



ZETA ST2 UP/DOWN

LED-3L651E950/350ZST/FP92/L100 O DALI 2/1 4K##

WWW.OSMONT.CZ

ZETA ST2 UP/DOWN

Product code: ZET60687

Type: LED-3L651E950/350ZST/FP92/L100 0 DALI 2/1 4K##

Short description of the luminaire: Olive green colour | pendant LED light DALI | two-circuit connection | direct and indirect lighting version | matt PMMA shade | textile cable pendant (with inner support wire) 100 cm |



Technical data

Types of luminaires	Dimmable
Mounting type	Suspended - cable
Base material	steel
Shade material	opal polymethyl methacrylate
Base color	Olive Ral6011
Shade color	white
Mounting location	ceiling
Width	600 mm
Length	600 mm
Height	50 mm
Diameter	ø 600 mm
Suspension length	1000 mm
mounting holes (diameter)	3xø5mm
Cable entrance	2xø16mm
Energy Class	B
Operating temperature	from -20°C to +30°C

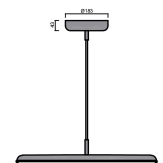
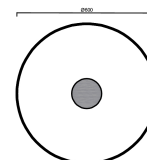

Electrical data

Power consumption	38+14 W
Ingress Protection	IP40
Socket	LED modul
terminal block	snap terminal block
Automatic circuit breaker type B10A	15 pcs
Automatic circuit breaker type B16A	25 pcs
Automatic circuit breaker type C10A	26 pcs
Automatic circuit breaker type C16A	42 pcs
Number of LED drivers	2

Luminous data

Lum. flux of luminaire	4700+1620 lm
Lum. flux of light source	6520+2380 lm
Luminaire efficacy	123 lm/W
Chromaticity temperature	4000 K
Rated life time LED L80/B10	100000 hours
CRI	Ra80
MacAdam	3
Blue light hazard	Risk group 0

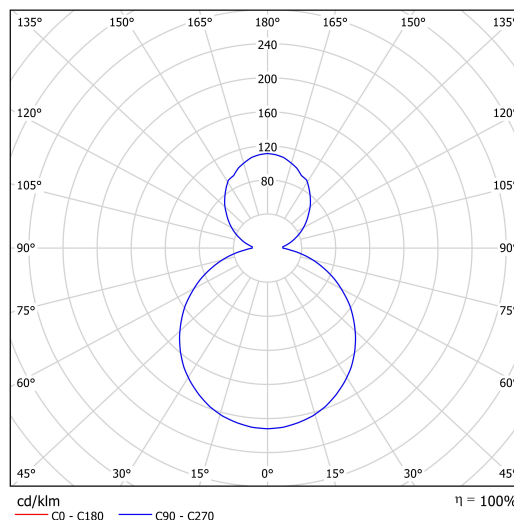

Eulum data for calculation programs are available at www.osmont.cz.

OSMONT, s.r.o.
HYBRÁLEC 129,
586 01 JIHLAVA, CZ

TECHNICAL SHEET



Logistical data

EAN	8591728235185
Warranty*	60 months

*The warranty for the batteries is valid for 36 months from the date of purchase.

Installation dimensions:

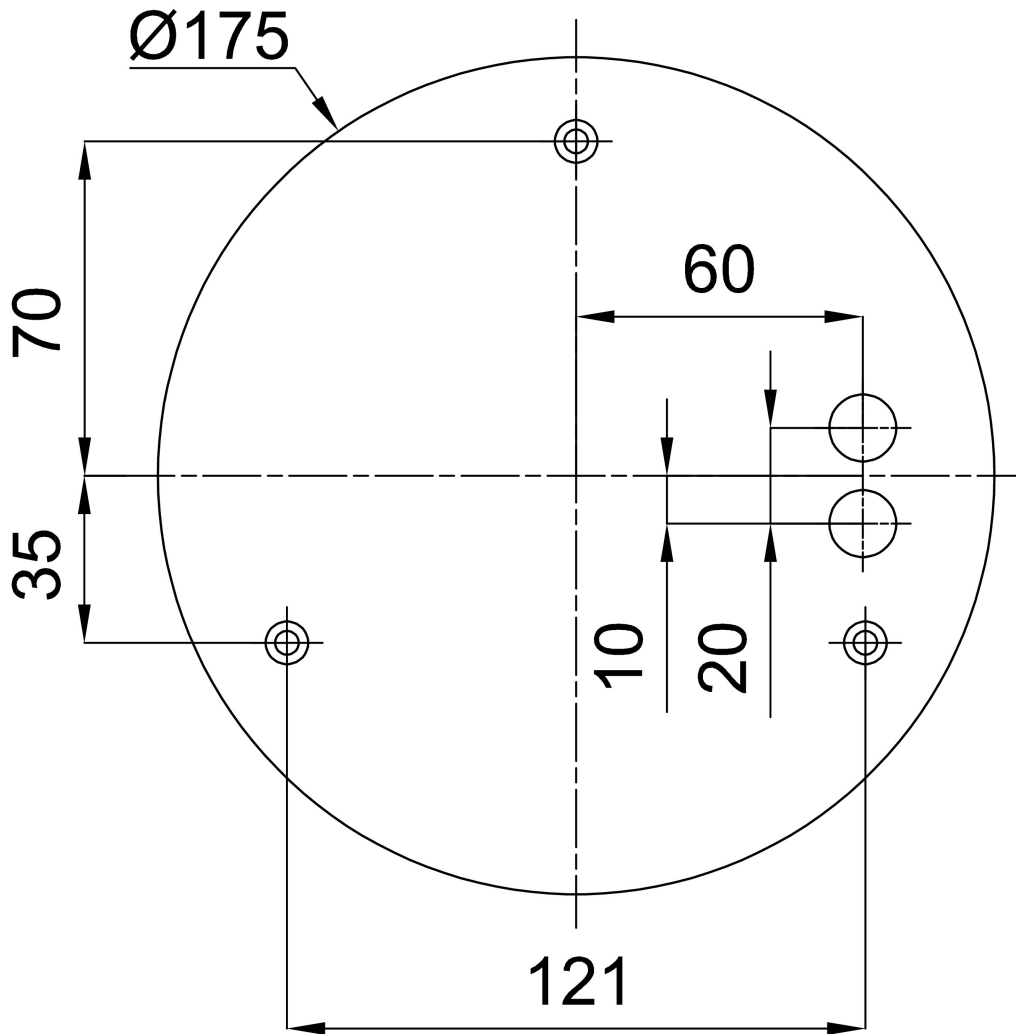

Additional assortment:

Lampshade

Product code	Name	Color	Picture	Drawing
20669	PM92	white		