



ZETA ST2 FP

LED-3L65E1050ZST/FP92/L100 SD 3K##

WWW.OSMONT.CZ

ZETA ST2 FP

Product code: ZET60064

Type: LED-3L65E1050ZST/FP92/L100 SD 3K##

Short description of the luminaire: Grey color | pendant LED light | ON/OFF | direct lighting version | PMMA matt shade



Technical

Types of luminaires	Classic on/off
Mounting type	Suspended - textile cable
Base material	steel
Shade material	opal polymethyl methacrylate
Base color	grey Ral7040
Shade color	white - grey
Mounting location	ceiling
Width	600 mm
Length	600 mm
Height	50 mm
Diameter	ø 600 mm
Hinge length	1000 mm
mounting holes (diameter)	3xø5mm
Installation wire (diameter)	2xø16mm
Energy Class	C
Operating temperature	from -20°C to +30°C

Electric

Power consumption	38 W
Ingress Protection	IP40
Socket	LED modul
terminal block	snap terminal block
Automatic circuit breaker type B10A	14 pcs
Automatic circuit breaker type B16A	22 pcs
Automatic circuit breaker type C10A	23 pcs
Automatic circuit breaker type C16A	36 pcs

Luminous

Lum. flux of luminaire	4590 lm
Lum. flux of light source	6370 lm
Luminaire efficacy	120 lm/W
Temperature	3000 K
Rated life time LED L80/B10	100000 hours
CRI	Ra80
MacAdam	3
Blue light hazard	Risk group 0

Eulum data for calculation programs are available at www.osmont.cz.

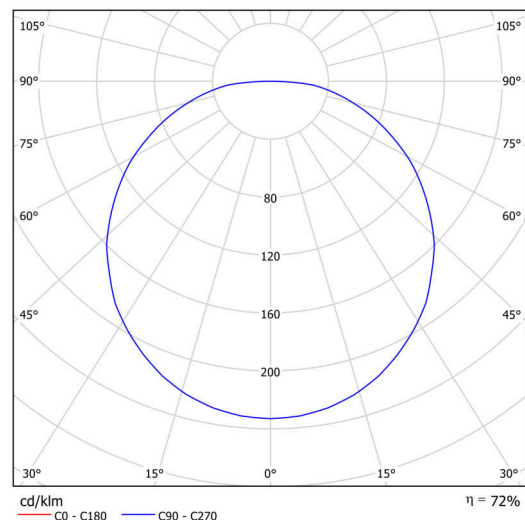
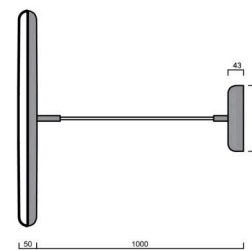
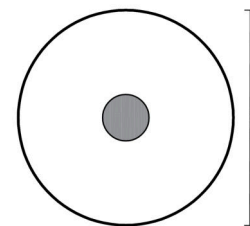

Logistic

EAN	8591728090913
Weight NTTO	6.06 Kg
Weight BTTO	6.8 Kg
Warranty*	60 months

*The warranty for the batteries is valid for 12 months from the date of purchase.

Installation dimensions:

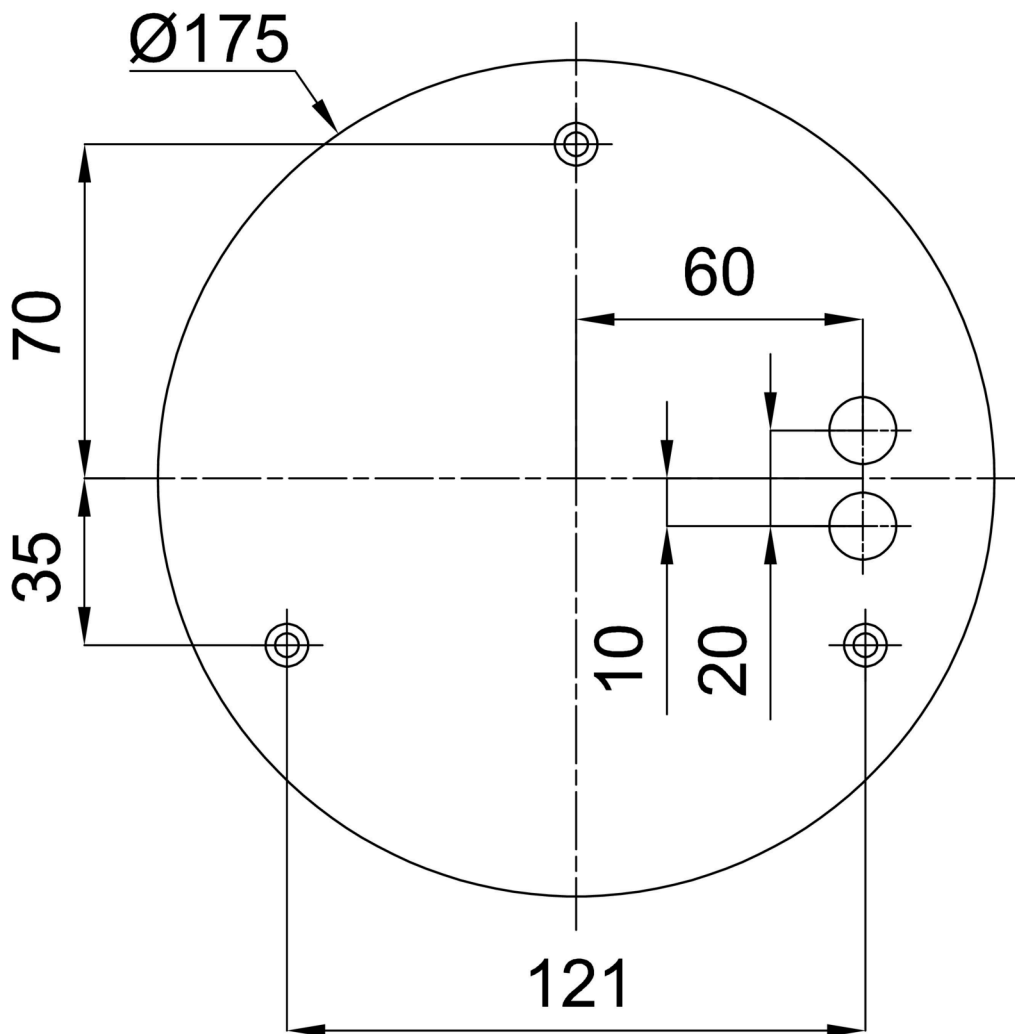

Additional assortment:

Lampshade

Product code	Name	Color	Description	Picture	Drawing
20669	PM92	white			