



ZETA ST1 UP/DOWN

LED-1L641E700/250ZST/FP91/L100 GB 2/1 DALI 4K#

WWW.OSMONT.CZ

ZETA ST1 UP/DOWN

Product code: ZET60659

Type: LED-1L641E700/250ZST/FP91/L100 GB 2/1 DALI 4K#

Short description of the luminaire: Golden beach colour | pendant LED light DALI | two-circuit connection | direct and indirect lighting version | matt PMMA shade | textile cable pendant (with inner support wire) 100 cm |

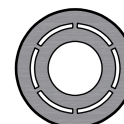
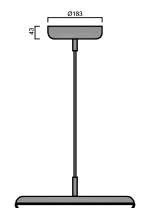
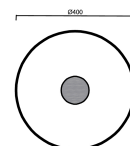

Technical data

Types of luminaires	Dimmable
Mounting type	Suspended - cable
Base material	steel
Shade material	opal polymethyl methacrylate
Base color	Golden Beach RAL1015
Shade color	white
Mounting location	ceiling
Width	400 mm
Length	400 mm
Height	50 mm
Diameter	ø 400 mm
Suspension length	1000 mm
mounting holes (diameter)	3xø5mm
Cable entrance	2xø16mm
Energy Class	C
Operating temperature	from -20°C to +30°C

Electrical data

Power consumption	31+11 W
Ingress Protection	IP40
Socket	LED modul
terminal block	snap terminal block
Automatic circuit breaker type B10A	15 pcs
Automatic circuit breaker type B16A	25 pcs
Automatic circuit breaker type C10A	26 pcs
Automatic circuit breaker type C16A	42 pcs
Number of LED drivers	2

Luminous data

Lum. flux of luminaire	3620+1220 lm
Lum. flux of light source	5030+1790 lm
Luminaire efficacy	116 lm/W
Chromaticity temperature	4000 K
Rated life time LED L80/B10	100000 hours
CRI	Ra80
MacAdam	3
Blue light hazard	Risk group 0

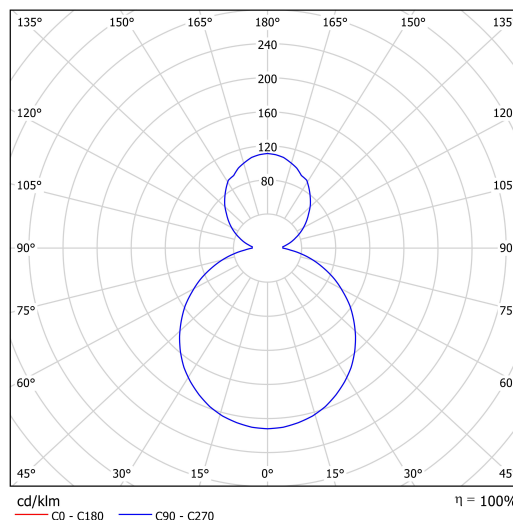

Eulum data for calculation programs are available at www.osmont.cz.

OSMONT, s.r.o.
HYBRÁLEC 129,
586 01 JIHLAVA, CZ

TECHNICAL SHEET



Logistical data

EAN	8591728234904
Weight NTTO	2.8 Kg
Weight BTTO	3.1 Kg
Warranty*	60 months

*The warranty for the batteries is valid for 36 months from the date of purchase.

Installation dimensions:

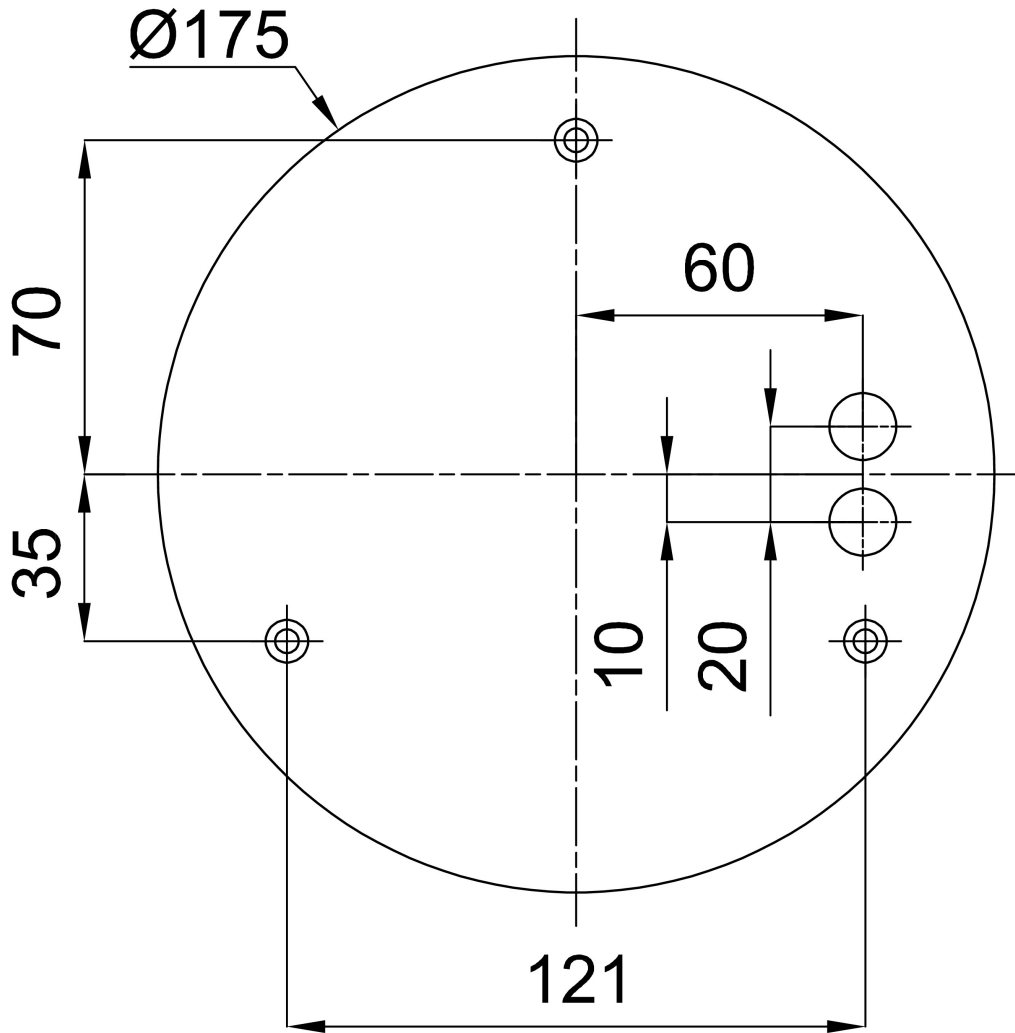

Additional assortment:

Lampshade

Product code	Name	Color	Picture	Drawing
20668	PM91	white		