



TRITON 2

LED-1L15E500/IN-184 B 3K#

WWW.OSMONT.CZ

TRITON 2

Product code: TRI57216

Type: LED-1L15E500/IN-184 B 3K#

Short description of the luminaire: White industrial LED light ON/OFF and polycarbonate shade.

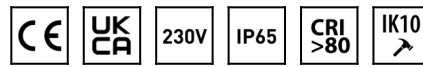

Technical

Types of luminaires	Classic on/off
Mounting type	industrial
Base material	polycarbonate
Shade material	opal polycarbonate
Base color	white Ra9003
Shade color	white
Holding the shade	bayonet
Mounting location	ceiling/wall
Width	360 mm
Length	360 mm
Height	108 mm
Diameter	ø 360 mm
mounting holes (diameter)	3xø5mm
Installation wire (diameter)	2xø16mm
Energy Class	D
Impact strength	IK10
Operating temperature	from -20°C to +30°C

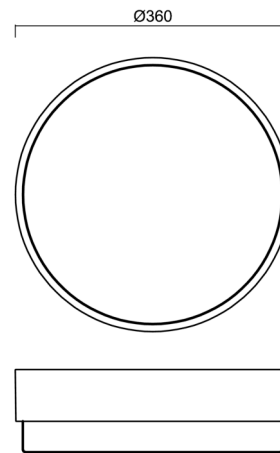

Electric

Power consumption	19 W
Ingress Protection	IP65
Socket	LED modul
terminal block	snap terminal block
Automatic circuit breaker type B10A	37 pcs
Automatic circuit breaker type B16A	59 pcs
Automatic circuit breaker type C10A	37 pcs
Automatic circuit breaker type C16A	59 pcs

Luminous

Lum. flux of luminaire	2460 lm
Lum. flux of light source	3000 lm
Luminaire efficacy	129 lm/W
Temperature	3000 K
Rated life time LED L80/B10	100000 hours
CRI	Ra80
MacAdam	3
Blue light hazard	Risk group 0

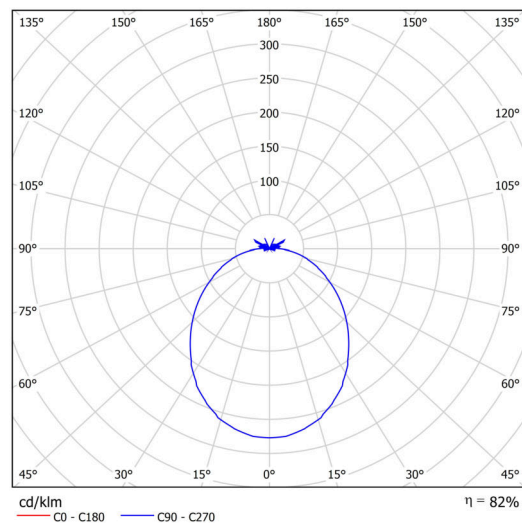

Eulum data for calculation programs are available at www.osmont.cz.

Logistic

EAN	8591728133894
Weight NTTO	1.4 Kg
Weight BTTO	1.7 Kg
Number of cartons	1 pcs
Package volume	0.019 m ³
Package 1 width	0.39 m
Package 1 length	0.37 m
Package 1 height	0.13 m
Warranty*	60 months

*The warranty for the batteries is valid for 12 months from the date of purchase.

Installation dimensions:

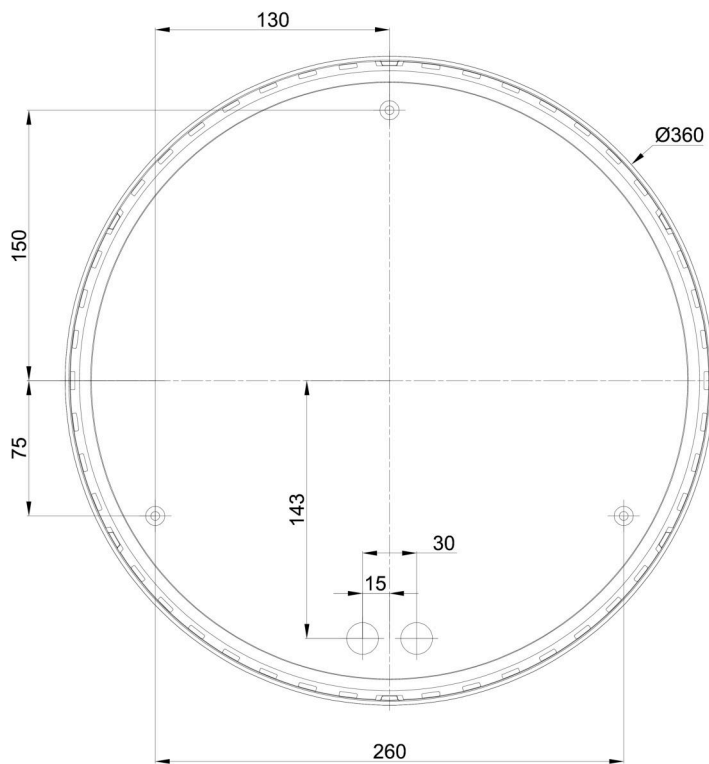

Additional assortment:

Lampshade

Product code	Name	Color	Description	Picture	Drawing
20550	184	white		