



TRITON 1

LED-1L14EMP700/IN-182/NK1W S 3K#

WWW.OSMONT.CZ

TRITON 1

Product code: TRI57215

Type: LED-1L14EMP700/IN-182/NK1W S 3K#

Short description of the luminaire: Silver industrial LED light with emergency unit combined and polycarbonate shade.



Technical

Types of luminaires	Emergency combined
Mounting type	industrial
Base material	polycarbonate
Shade material	opal polycarbonate
Base color	silver Ral9006
Shade color	white
Holding the shade	bayonet
Mounting location	ceiling/wall
Width	280 mm
Length	280 mm
Height	95 mm
Diameter	ø 280 mm
mounting holes (diameter)	3xø5mm
Installation wire (diameter)	2xø16mm
Energy Class	D
Impact strength	IK10
Operating temperature	from 0°C to +30°C

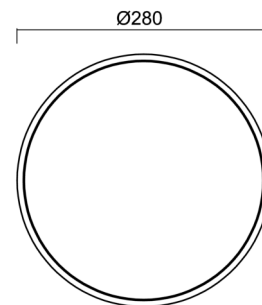

Electric

Power consumption	18 W
Ingress Protection	IP65
Socket	LED modul
Battery type	NiCd
Emergency time	3 hours
terminal block	snap terminal block
Automatic circuit breaker type B10A	23 pcs
Automatic circuit breaker type B16A	36 pcs
Automatic circuit breaker type C10A	40 pcs
Automatic circuit breaker type C16A	64 pcs

Luminous

Lum. flux of luminaire	2210 lm
Lum. flux of light source	2690 lm
Lum. flux of light source in emergency mode	150 lm
Luminaire efficacy	122 lm/W
Temperature	3000 K
Rated life time LED L80/B10	100000 hours
CRI	Ra80
MacAdam	3
Blue light hazard	Risk group 0

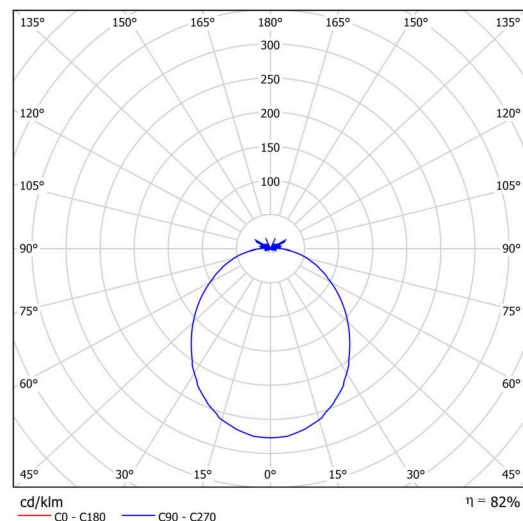

TECHNICAL SHEET



Eulum data for calculation programs are available at www.osmont.cz.

Multipower

Possibility of output adjustment by the user (DIP switch on the current source).

I [mA]	700	650	600	550	500	450	400	350
[%]	100	93	86	79	71	64	57	50

Logistic

EAN	8591728133887
Weight NTTO	1.5 Kg
Weight BTTO	1.7 Kg
Number of cartons	1 pcs
Package volume	0.012 m ³
Package 1 width	0.31 m
Package 1 length	0.29 m
Package 1 height	0.13 m
Warranty*	60 months

*The warranty for the batteries is valid for 12 months from the date of purchase.

Installation dimensions:

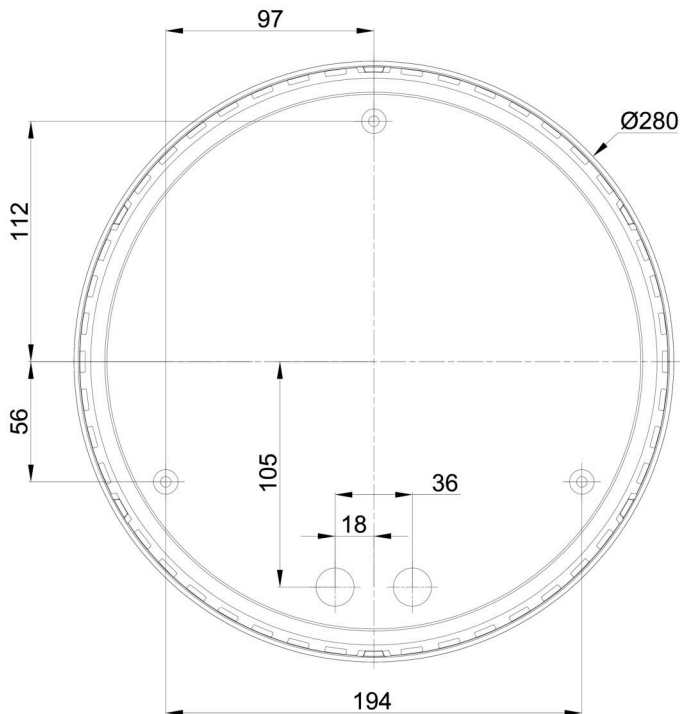

Additional assortment:

Lampshade

Product code	Name	Color	Description	Picture	Drawing
20549	182	white			