



TITAN V3

LED-1L23EMP1050KNV94/PM09 HF 4K##

WWW.OSMONT.CZ

TITAN V3

Product code: TIT65561

Type: LED-1L23EMP1050KNV94/PM09 HF 4K##

Short description of the luminaire: White semi-recessed LED light with sensor and PMMA shade.



Technical

Types of luminaires	Sensor
Mounting type	semi-recessed
Base material	steel
Shade material	opal polymethyl methacrylate
Base color	white Ra9003
Shade color	white
Holding the shade	folding system
Mounting location	ceiling/wall
Width	500 mm
Length	500 mm
Height	115 mm
Diameter	ø 500 mm
mounting holes (diameter)	none
Installation wire (diameter)	2xø16mm
Energy Class	D
Impact strength	IK04
Operating temperature	from -20°C to +30°C

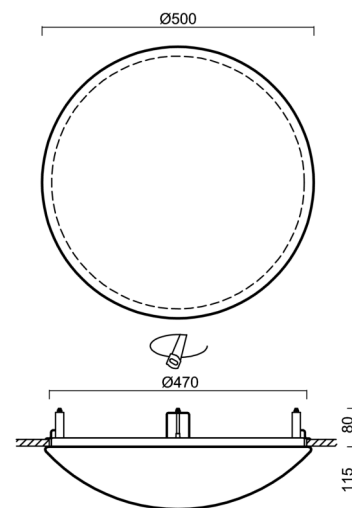

Electric

Power consumption	54 W
Ingress Protection	IP44
Socket	LED modul
Sensor	HF
terminal block	snap terminal block
Automatic circuit breaker type B10A	24 pcs
Automatic circuit breaker type B16A	40 pcs
Automatic circuit breaker type C10A	24 pcs
Automatic circuit breaker type C16A	40 pcs

Luminous

Lum. flux of luminaire	5820 lm
Lum. flux of light source	8430 lm
Luminaire efficacy	107 lm/W
Temperature	4000 K
Rated life time LED L80/B10	100000 hours
CRI	Ra80
MacAdam	3
Blue light hazard	Risk group 0

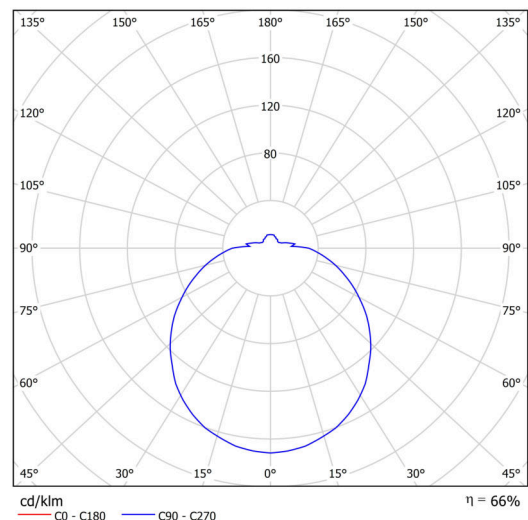

Eulum data for calculation programs are available at www.osmont.cz.

TECHNICAL SHEET



Multipower

Possibility of output adjustment by the user (DIP switch on the current source).

I [mA]	1050	900	850	700	
[%]	100	86	81	67	

Logistic

EAN	8591728132606
Weight NTTO	3.3 Kg
Weight BTTO	3.8 Kg
Number of cartons	1 pcs
Package volume	0.047 m ³
Package 1 width	0.51 m
Package 1 length	0.51 m
Package 1 height	0.18 m
Warranty*	60 months

*The warranty for the batteries is valid for 12 months from the date of purchase.

Installation dimensions:

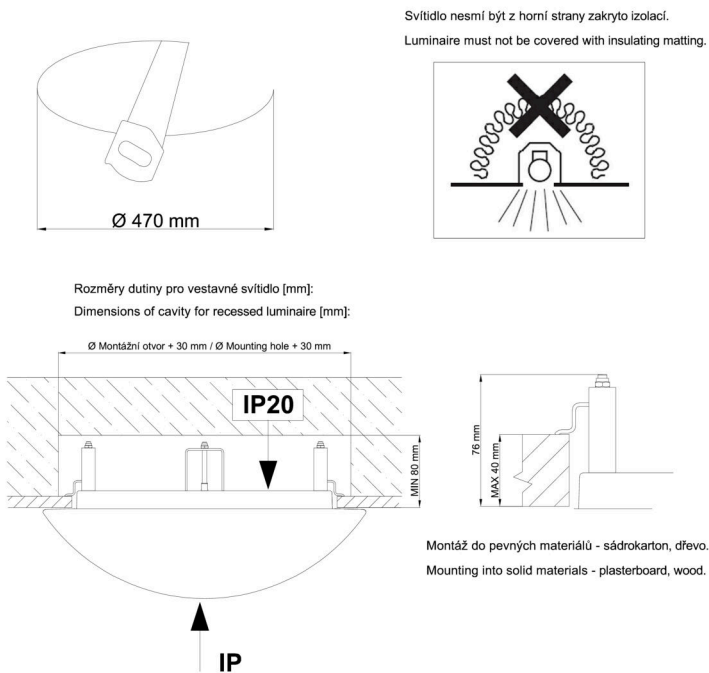

Additional assortment:

Lampshade

Product code	Name	Color	Description	Picture	Drawing
20509	PM09	white		