

TITAN LE3

LED-1L23E950ZLEN94/PM09/L100 DALI 4K##

WWW.OSMONT.CZ

TITAN LE3

Product code: TIT68515

Type: LED-1L23E950ZLEN94/PM09/L100 DALI 4K##

Short description of the luminaire: White pendant LED light DALI and PMMA shade.

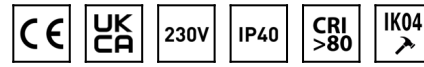

Technical

Types of luminaires	Dimmable
Mounting type	Suspended - SELV wire (cableless)
Base material	steel
Shade material	opal polymethyl methacrylate
Base color	white Ral9003
Shade color	white
Holding the shade	folding system
Mounting location	ceiling
Width	500 mm
Length	500 mm
Height	120 mm
Diameter	ø 500 mm
Hinge length	1000 mm
mounting holes (diameter)	3xø5mm
Installation wire (diameter)	2xø16mm
Energy Class	D
Impact strength	IK04
Operating temperature	from -20°C to +30°C

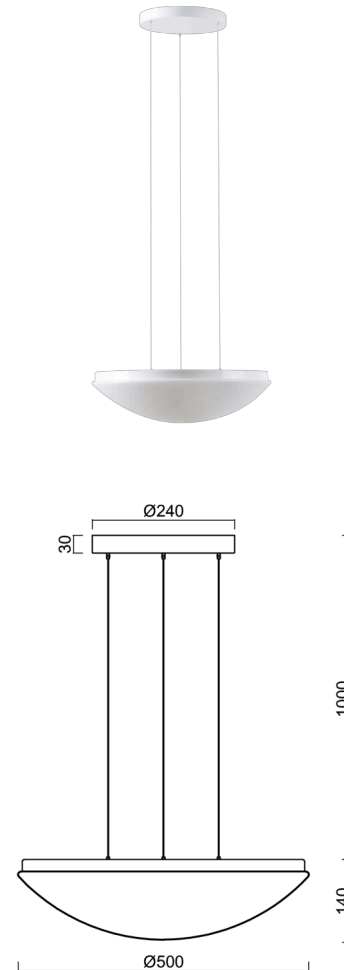

Electric

Power consumption	48 W
Ingress Protection	IP40
Socket	LED modul
terminal block	snap terminal block
Automatic circuit breaker type B10A	13 pcs
Automatic circuit breaker type B16A	22 pcs
Automatic circuit breaker type C10A	21 pcs
Automatic circuit breaker type C16A	36 pcs

Luminous

Lum. flux of luminaire	5040 lm
Lum. flux of light source	7750 lm
Luminaire efficacy	105 lm/W
Temperature	4000 K
Rated life time LED L80/B10	100000 hours
CRI	Ra80
MacAdam	3
Blue light hazard	Risk group 0

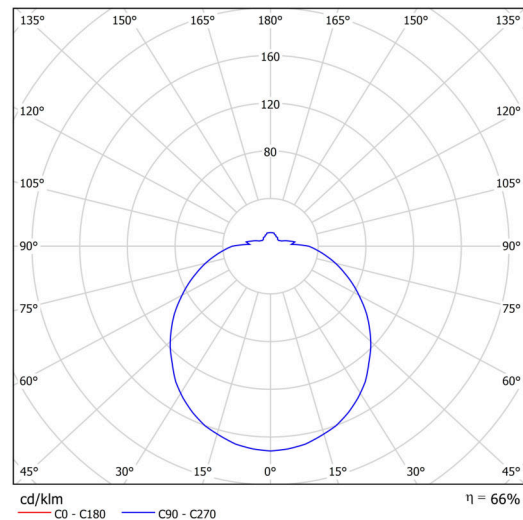

Eulum data for calculation programs are available at www.osmont.cz.

Logistic

EAN	8591728133085
Weight NTTO	2.9 Kg
Weight BTTO	3.4 Kg
Number of cartons	1 pcs
Package volume	0.057 m ³
Package 1 width	0.52 m
Package 1 length	0.52 m
Package 1 height	0.21 m
Warranty*	60 months

*The warranty for the batteries is valid for 12 months from the date of purchase.

Installation dimensions:

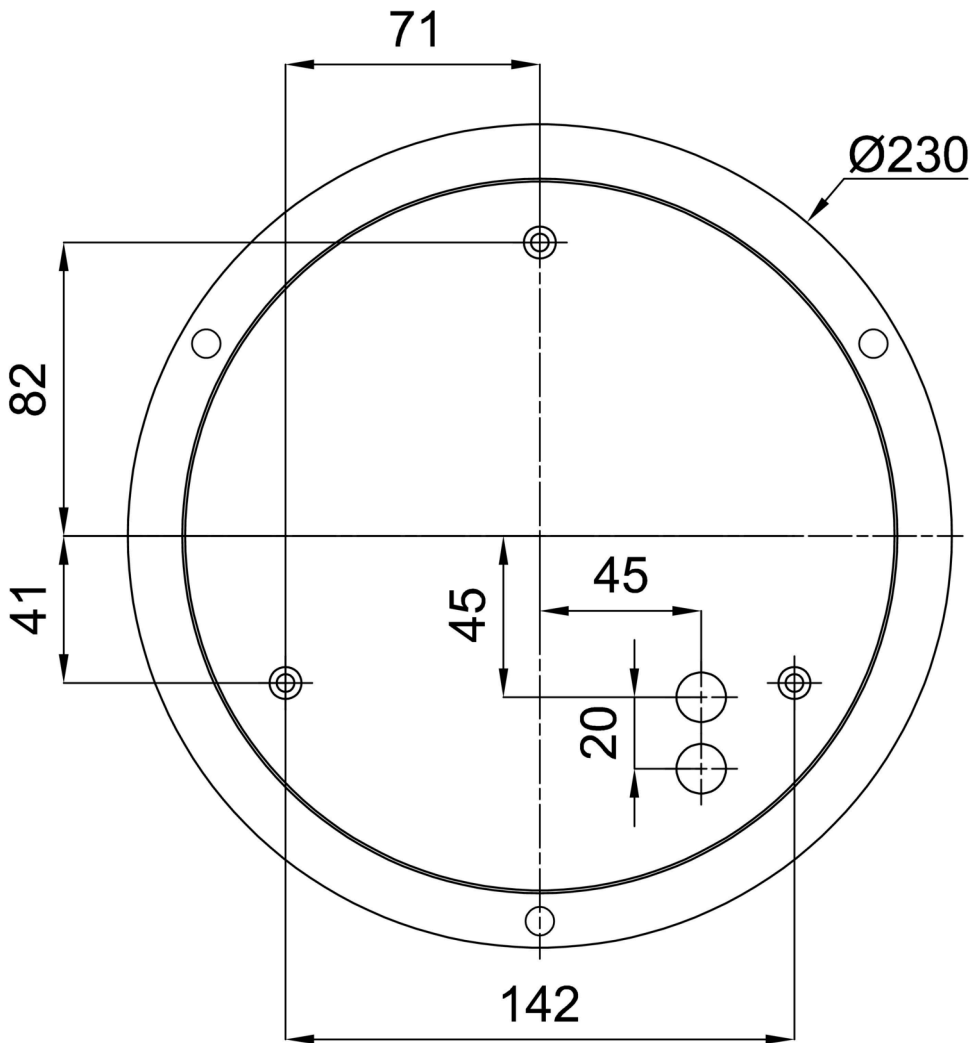

Additional assortment:

Lampshade

Product code	Name	Color	Description	Picture	Drawing
20509	PM09	white		