



## TITAN L5

---

LED-9L52E1050ZLN11/PM11/L100 DALI 3K##

[WWW.OSMONT.CZ](http://WWW.OSMONT.CZ)

# TITAN L5

Product code: TIT66355

Type: LED-9L52E1050ZLN11/PM11/L100 DALI 3K##

Short description of the luminaire: White pendant LED light DALI and PMMA shade.

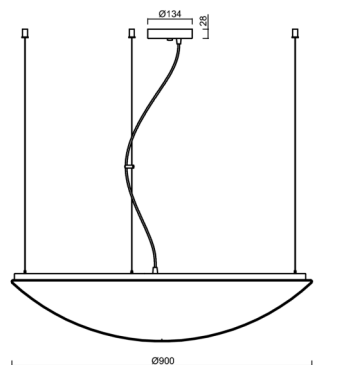

## Technical

Types of luminaires	Dimmable
Mounting type	Suspended - wire
Base material	steel
Shade material	opal polymethyl methacrylate
Base color	white Ra9003
Shade color	white
Holding the shade	folding system
Mounting location	ceiling
Width	900 mm
Length	900 mm
Height	200 mm
Diameter	ø 900 mm
Hinge length	1000 mm
mounting holes (diameter)	2xø5mm
Installation wire (diameter)	2xø16mm
Energy Class	D
Impact strength	IK04
Operating temperature	from -20°C to +30°C

## Electric

Power consumption	150 W
Ingress Protection	IP40
Socket	LED modul
terminal block	screw terminal block
Automatic circuit breaker type B10A	4 pcs
Automatic circuit breaker type B16A	7 pcs
Automatic circuit breaker type C10A	7 pcs
Automatic circuit breaker type C16A	11 pcs

## Luminous

Lum. flux of luminaire	15910 lm
Lum. flux of light source	22730 lm
Luminaire efficacy	106 lm/W
Temperature	3000 K
Rated life time LED L80/B10	100000 hours
CRI	Ra80
MacAdam	3
Blue light hazard	Risk group 0

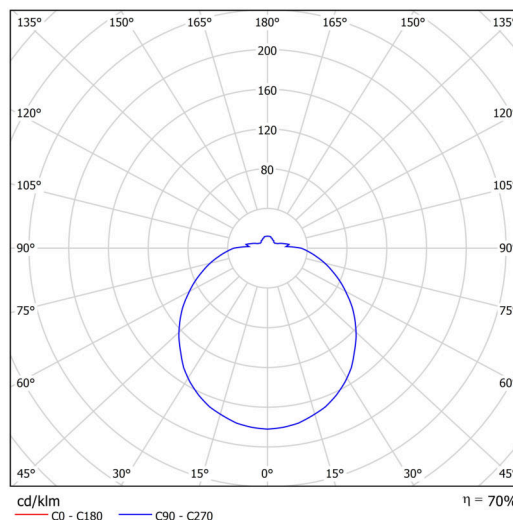

Eulum data for calculation programs are available at [www.osmont.cz](http://www.osmont.cz).

Logistic

EAN	8591728132705
Weight NTTO	10 Kg
Weight BTTO	12.7 Kg
Number of cartons	1 pcs
Package volume	0.205 m <sup>3</sup>
Package 1 width	0.95 m
Package 1 length	0.23 m
Package 1 height	0.94 m
Warranty*	60 months

\*The warranty for the batteries is valid for 12 months from the date of purchase.

Installation dimensions:



## Additional assortment:

## Lampshade

Product code	Name	Color	Description	Picture	Drawing
20516	PM11	white		