

TITAN L4

LED-6L51EMP1050ZLN10/PM10/L100 3K##

WWW.OSMONT.CZ

TITAN L4

Product code: TIT73026

Type: LED-6L51EMP1050ZLN10/PM10/L100 3K##

Short description of the luminaire: White color | pendant LED light | ON/OFF | PMMA matt shade | multipower function | black decorative foil stripe



Technical

Types of luminaires	Classic on/off
Mounting type	Suspended - wire
Base material	steel
Shade material	opal polymethyl methacrylate
Base color	white Ral9003
Shade color	white
Holding the shade	folding system
Mounting location	ceiling
Width	650 mm
Length	650 mm
Height	130 mm
Diameter	ø 650 mm
Hinge length	1000 mm
mounting holes (diameter)	2xø5mm
Installation wire (diameter)	2xø16mm
Energy Class	D
Impact strength	IK04
Operating temperature	from -20°C to +30°C

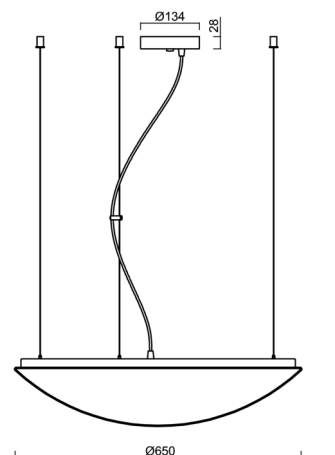
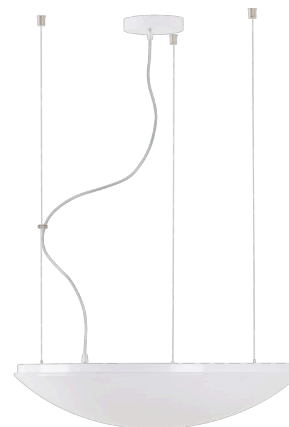

Electric

Power consumption	100 W
Ingress Protection	IP40
Socket	LED modul
terminal block	screw terminal block
Automatic circuit breaker type B10A	12 pcs
Automatic circuit breaker type B16A	20 pcs
Automatic circuit breaker type C10A	12 pcs
Automatic circuit breaker type C16A	20 pcs

Luminous

Lum. flux of luminaire	10010 lm
Lum. flux of light source	15160 lm
Luminaire efficacy	100 lm/W
Temperature	3000 K
Rated life time LED L80/B10	100000 hours
CRI	Ra80
MacAdam	3
Blue light hazard	Risk group 0

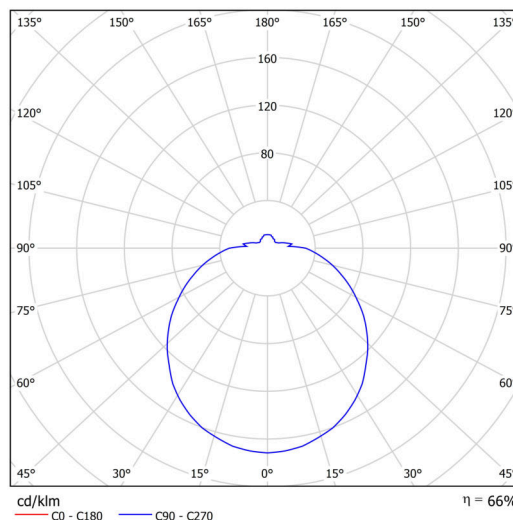

Eulum data for calculation programs are available at www.osmont.cz.

TECHNICAL SHEET



Multipower

Possibility of output adjustment by the user (DIP switch on the current source).

I [mA]	1050	900	850	700	
[%]	100	86	81	67	

Logistic

EAN	8591728133474
Weight NTTO	5.6 Kg
Weight BTTO	7 Kg
Number of cartons	1 pcs
Package volume	0.08 m ³
Package 1 width	0.68 m
Package 1 length	0.17 m
Package 1 height	0.67 m
Warranty*	60 months

*The warranty for the batteries is valid for 12 months from the date of purchase.

Installation dimensions:



Additional assortment:

Lampshade

Product code	Name	Color	Description	Picture	Drawing
20515	PM10	white		