

TITAN D1

LED-1L14E700KN62/PC06/DP T DALI 3K#

WWW.OSMONT.CZ

TITAN D1

Product code: TIT56277

Type: LED-1L14E700KN62/PC06/DP T DALI 3K#

Short description of the luminaire: Terracotta colour | ceiling or wall LED light DALI | opal polycarbonate shade (PC) with decorative collar



Technical data

Types of luminaires	Dimmable
Mounting type	surface mounted
Base material	steel
Shade material	opal polycarbonate
Base color	terracotta Ral2013
Shade color	white
Holding the shade	folding system
Mounting location	ceiling/wall
Width	338 mm
Length	85 mm
Height	338 mm
Diameter	ø 338 mm
mounting holes (diameter)	2xø5mm
Cable entrance	2xø16mm
Energy Class	D
Impact strength	IK10
Operating temperature	from -20°C to +30°C

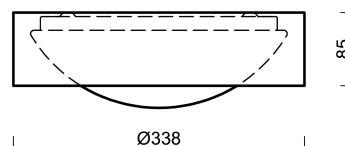
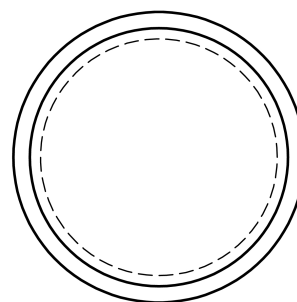

Electrical data

Power consumption	18 W
Ingress Protection	IP54
Socket	LED modul
terminal block	snap terminal block

Luminous data

Lum. flux of luminaire	1590 lm
Lum. flux of light source	2690 lm
Chromaticity temperature	3000 K
Rated life time LED L80/B10	100000 hours
CRI	Ra80
MacAdam	3
Blue light hazard	Risk group 0

Eulum data for calculation programs are available at www.osmont.cz.

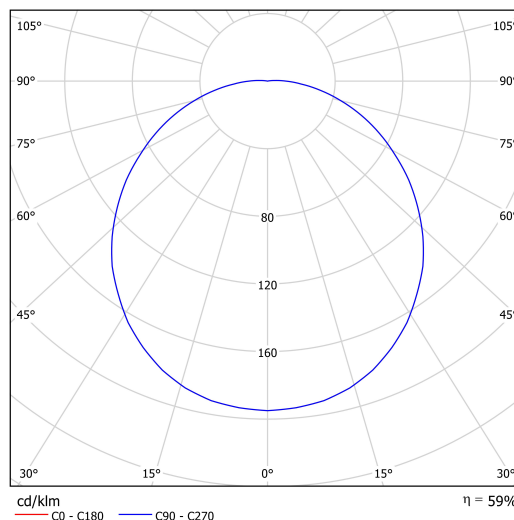

Logistical data

EAN	8591728232924
Number of cartons	1 pcs
Warranty*	60 months

*The warranty for the batteries is valid for 36 months from the date of purchase.

Installation dimensions:

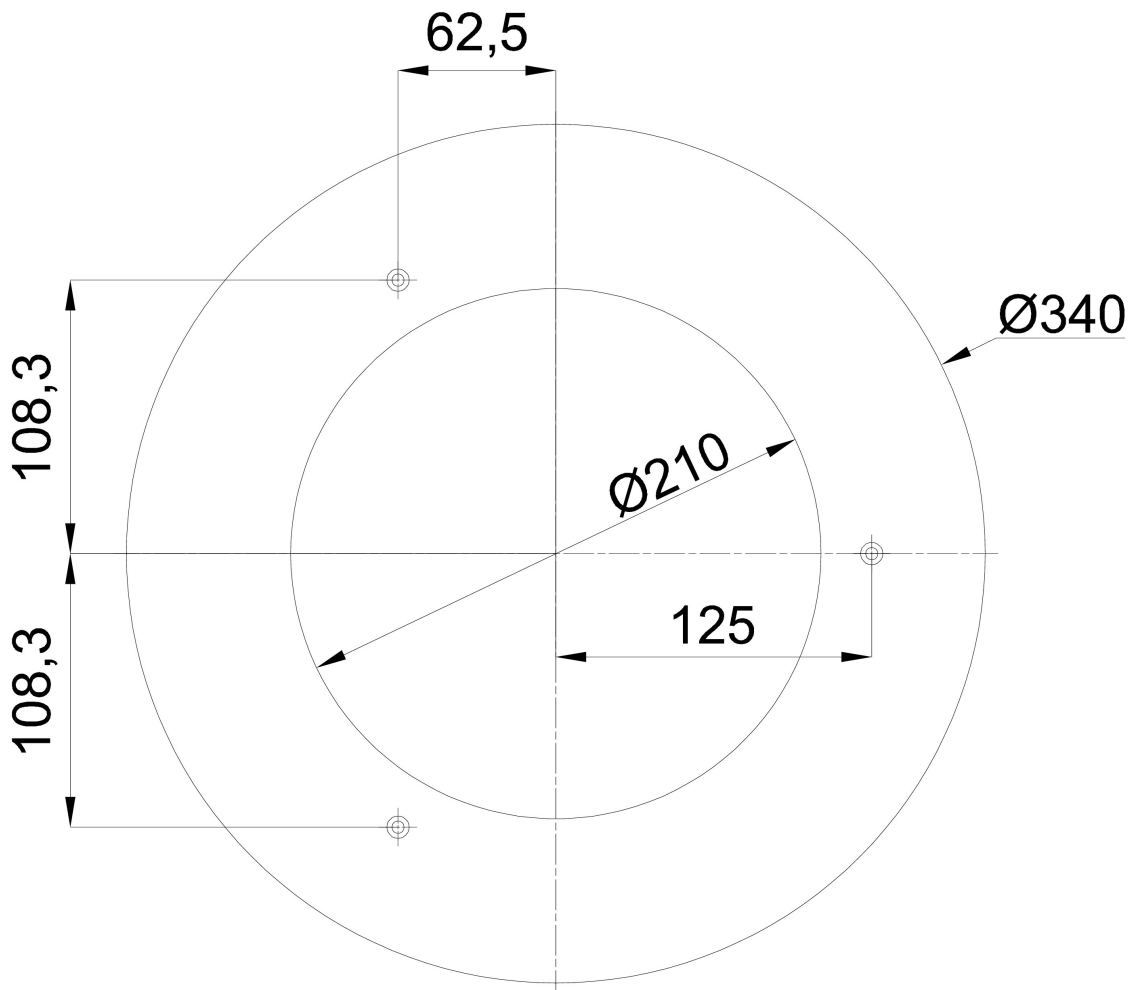

Additional assortment:

Decorative collar

Product code	Name	Color	Picture	Drawing
33546	KN6/DP T	terracotta Ral2013		

Lampshade

Product code	Name	Color	Picture	Drawing
20504	PC06	white	