



TITAN 3

LED-1L23ET1050KN94/PC09 DALI 27-65K##

WWW.OSMONT.CZ

TITAN 3

Product code: TIT63174

Type: LED-1L23ET1050KN94/PC09 DALI 27-65K##

Short description of the luminaire: White color | surface-mounted LED light | Tunable White system | polycarbonate shade

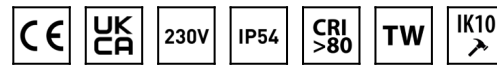

Technical

Types of luminaires	Tunable White
Mounting type	surface mounted
Base material	steel
Shade material	opal polycarbonate
Base color	white Ra9003
Shade color	white
Holding the shade	folding system
Mounting location	ceiling/wall
Width	500 mm
Length	500 mm
Height	130 mm
Diameter	ø 500 mm
mounting holes (diameter)	3xø5mm
Installation wire (diameter)	2xø16mm
Energy Class	D
Impact strength	IK10
Operating temperature	from -20°C to +30°C

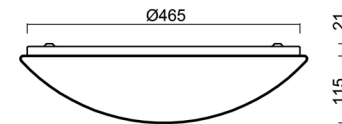
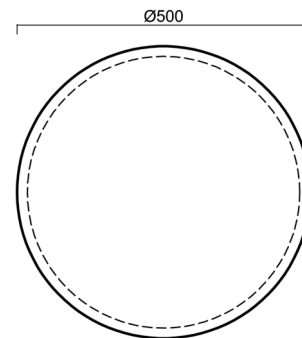

Electric

Power consumption	52 W
Ingress Protection	IP54
Socket	LED modul
terminal block	snap terminal block
Automatic circuit breaker type B10A	14 pcs
Automatic circuit breaker type B16A	23 pcs

Luminous

Lum. flux of luminaire	5370 lm
Lum. flux of light source	8140 lm
Luminaire efficacy	103 lm/W
Temperature	2700-6500 K
Rated life time LED L80/B10	100000 hours
CRI	Ra80
MacAdam	3
Blue light hazard	Risk group 0

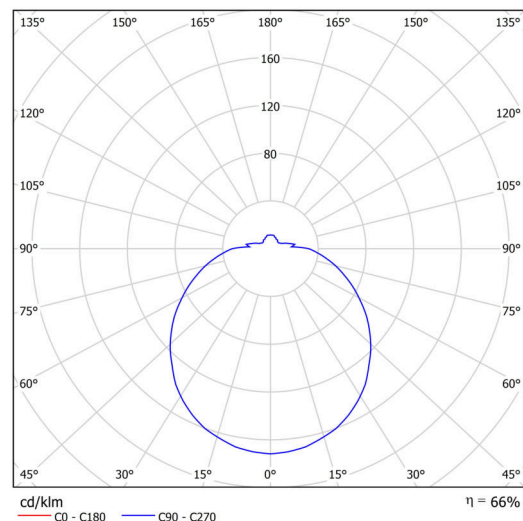

Eulum data for calculation programs are available at www.osmont.cz.

Logistic

EAN	8591728090234
Weight NTTO	2.8 Kg

TECHNICAL SHEET

Weight BTTO	3.3 Kg
Number of cartons	1 pcs
Package volume	0.036 m ³
Package 1 width	0.515 m
Package 1 length	0.495 m
Package 1 height	0.14 m
Warranty*	60 months

*The warranty for the batteries is valid for 12 months from the date of purchase.

Installation dimensions:

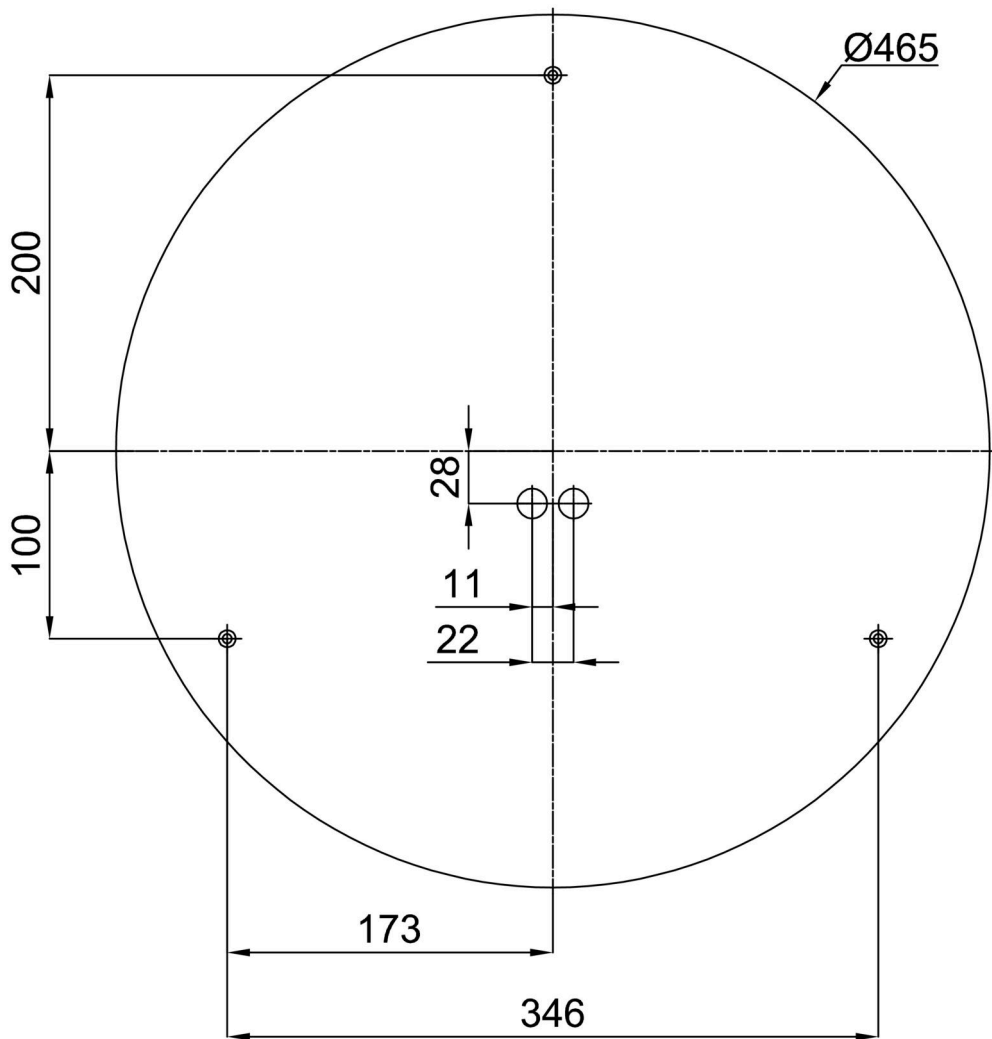

Additional assortment:

Base for surface mounting

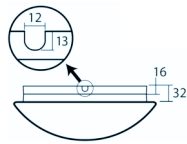
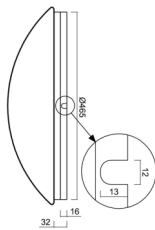
Product code	Name	Color	Description	Picture	Drawing
33503	KN9,K9,B17 /BP	white Ra19003			

Lampshade

Product code	Name	Color	Description	Picture	Drawing
20506	PC09	white		