



## TITAN 3

---

LED-1L23E700KN94/PC09 DALI 3K##

[WWW.OSMONT.CZ](http://WWW.OSMONT.CZ)

# TITAN 3

Product code: TIT56236

Type: LED-1L23E700KN94/PC09 DALI 3K##

Short description of the luminaire: White surface-mounted LED light DALI and polycarbonate shade.

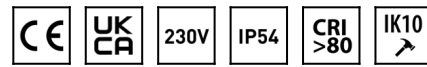

## Technical

Types of luminaires	Dimmable
Mounting type	surface mounted
Base material	steel
Shade material	opal polycarbonate
Base color	white Ra9003
Shade color	white
Holding the shade	folding system
Mounting location	ceiling/wall
Width	500 mm
Length	500 mm
Height	130 mm
Diameter	ø 500 mm
mounting holes (diameter)	3xø5mm
Installation wire (diameter)	2xø16mm
Energy Class	D
Impact strength	IK10

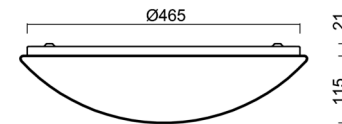
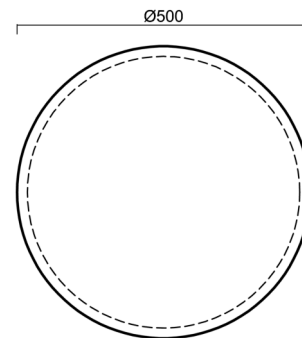

## Electric

Power consumption	35 W
Ingress Protection	IP54
Socket	LED modul
terminal block	snap terminal block
Automatic circuit breaker type B10A	18 pcs
Automatic circuit breaker type B16A	28 pcs
Automatic circuit breaker type C10A	30 pcs
Automatic circuit breaker type C16A	46 pcs

## Luminous

Lum. flux of luminaire	3700 lm
Lum. flux of light source	5610 lm
Luminaire efficacy	105 lm/W
Temperature	3000 K
Rated life time LED L80/B10	100000 hours
CRI	Ra80
MacAdam	3
Blue light hazard	Risk group 0

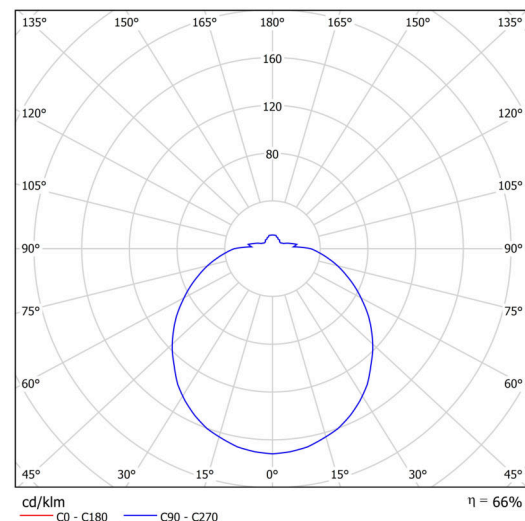

Eulum data for calculation programs are available at [www.osmont.cz](http://www.osmont.cz).

Logistic

EAN	8591728130350
Weight NTTO	2.8 Kg
Weight BTTO	3.3 Kg
Number of cartons	1 pcs
Package volume	0.036 m <sup>3</sup>
Package 1 width	0.515 m
Package 1 length	0.495 m
Package 1 height	0.14 m
Warranty*	60 months

\*The warranty for the batteries is valid for 12 months from the date of purchase.

Installation dimensions:

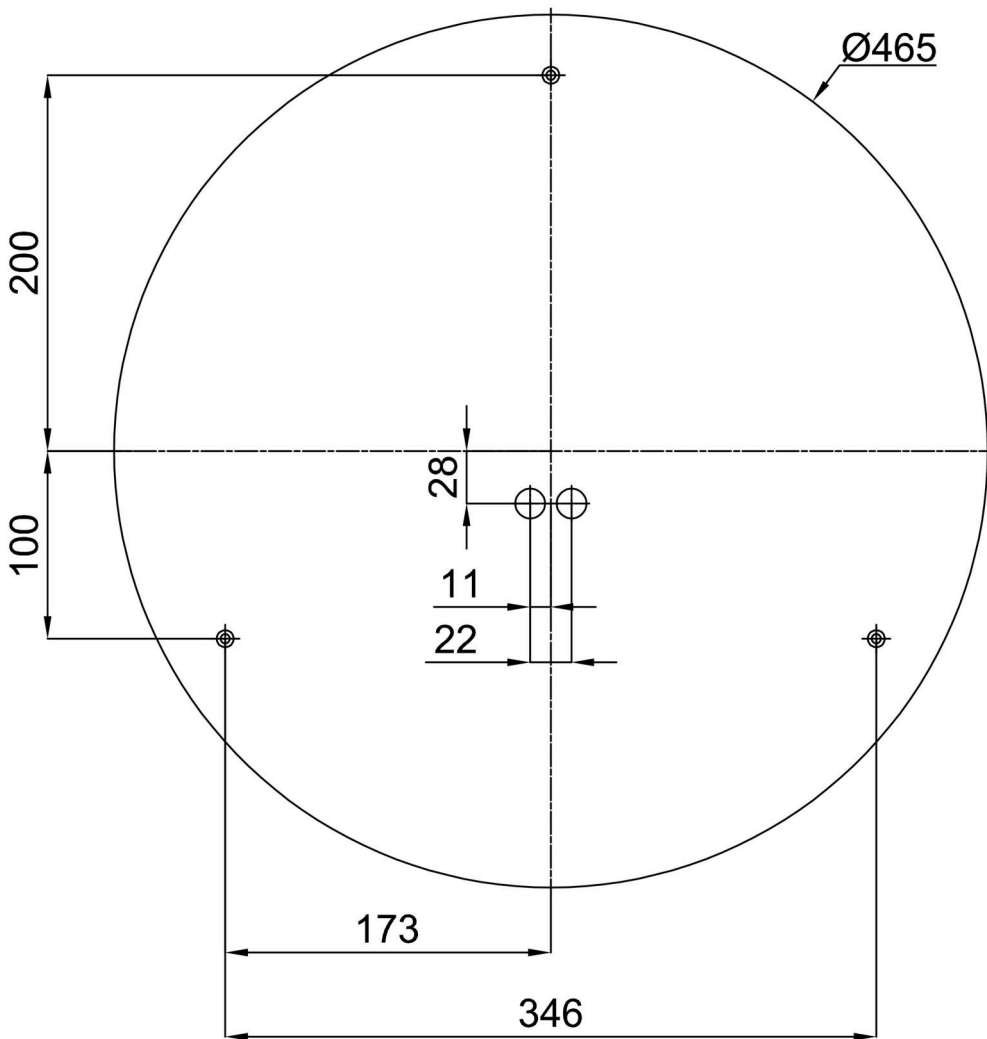

Additional assortment:

Base for surface mounting

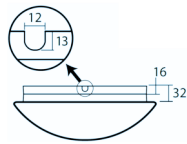
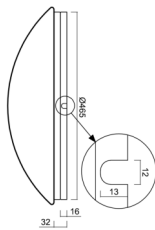
Product code	Name	Color	Description	Picture	Drawing
33503	KN9,K9,B17 /BP	white Ra19003			

Lampshade

Product code	Name	Color	Description	Picture	Drawing
20506	PC09	white		