



TITAN 2

LED-1L16EMP700KN83/PM08 NK3HST 4K#

WWW.OSMONT.CZ

TITAN 2

Product code: TIT66872

Type: LED-1L16EMP700KN83/PM08 NK3HST 4K#

Short description of the luminaire: White colour | ceiling or wall LED light with emergency backup combined (with Self-test) | multipower driver | opal polycarbonate shade (PC)



Technical

Types of luminaires	Emergency combined SELFTEST
Mounting type	surface mounted
Base material	steel
Shade material	opal polymethyl methacrylate
Base color	white Ral9003
Shade color	white
Holding the shade	folding system
Mounting location	ceiling/wall
Width	400 mm
Length	400 mm
Height	115 mm
mounting holes (diameter)	3xØ5mm
Cable entrance	2xØ16mm
Energy Class	D
Impact strength	IK04
Operating temperature	from -20°C to +30°C

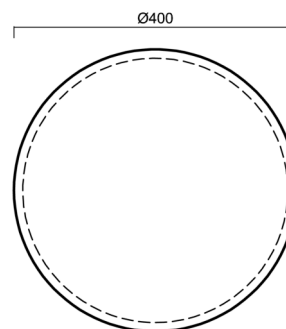

Electric

Power consumption	34 W
Ingress Protection	IP54
Socket	LED modul
Battery type	LiFePO4
Emergency time	3 hours
SELFTEST	yes
terminal block	snap terminal block

Luminous

Lum. flux of luminaire	3640 lm
Lum. flux of light source	5270 lm
Lum. flux of light source in emergency mode	200 lm
Temperature	4000 K
Rated life time LED L80/B10	100000 hours
CRI	Ra80
MacAdam	3
Blue light hazard	Risk group 0

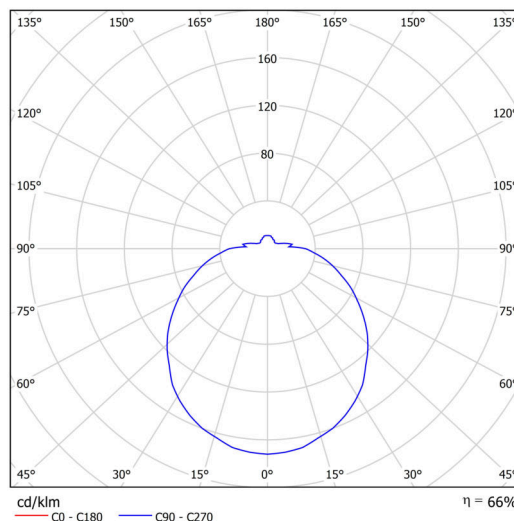

Eulum data for calculation programs are available at www.osmont.cz.

Logistic

EAN	8591728159887
-----	---------------

TECHNICAL SHEET



Weight NTTO	1.8 Kg
Weight BTTO	2.2 Kg
Number of cartons	1 pcs
Package volume	0.02 m ³
Package 1 width	0.405 m
Package 1 length	0.42 m
Package 1 height	0.12 m
Warranty*	60 months

*The warranty for the batteries is valid for 12 months from the date of purchase.

Installation dimensions:

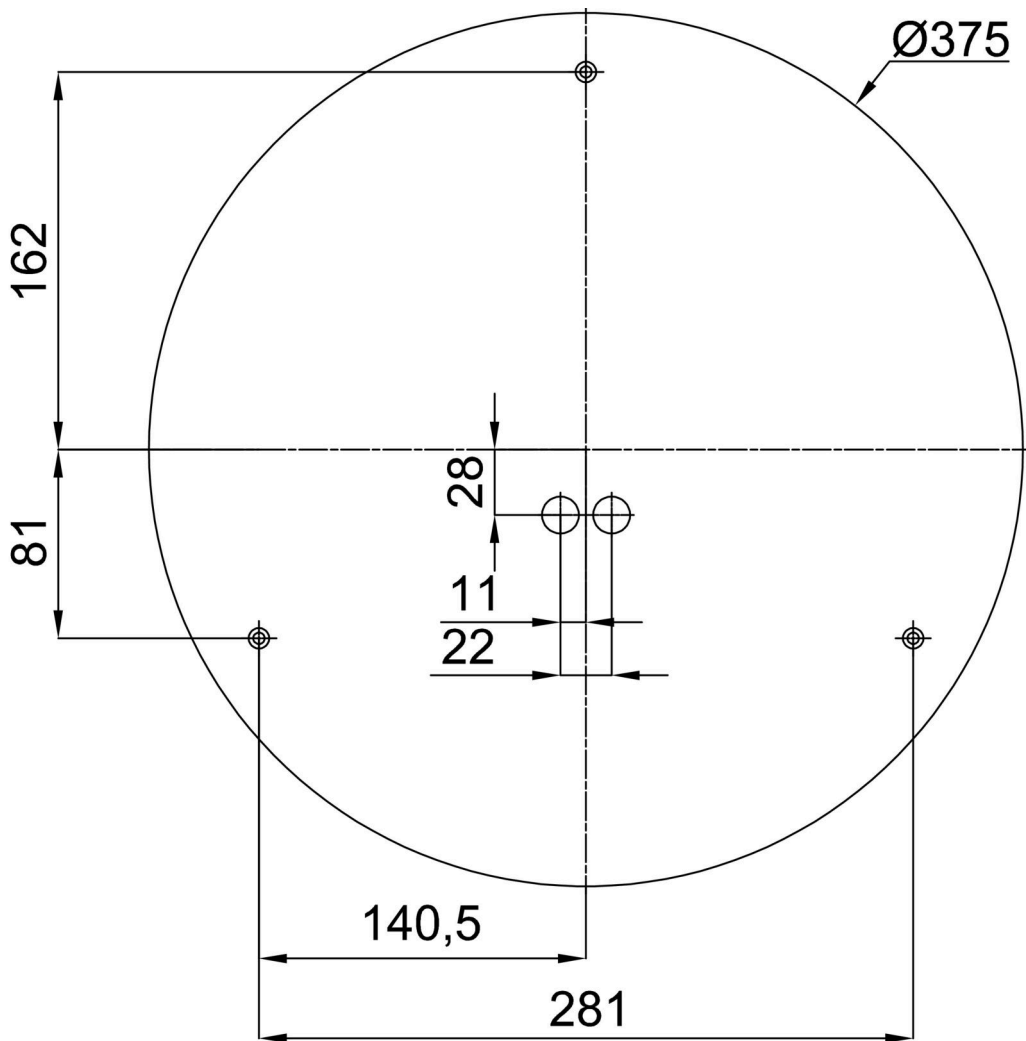

Additional assortment:

Base for surface mounting

Product code	Name	Color	Description	Picture	Drawing
33502	KN8,K8/BP	white Ra19003	příslušenství		

Lampshade

Product code	Name	Color	Description	Picture	Drawing
20508	PM08	white	příslušenství	