



TITAN 2

LED-1L16ET700KN83/PM08 BT 27-65K#

WWW.OSMONT.CZ

TITAN 2

Product code: TIT63160

Type: LED-1L16ET700KN83/PM08 BT 27-65K#

Short description of the luminaire: White surface-mounted LED light Tunable White and PMMA shade.



Technical

Types of luminaires	Tunable White
Mounting type	surface mounted
Base material	steel
Shade material	opal polymethyl methacrylate
Base color	white Ra9003
Shade color	white
Holding the shade	folding system
Mounting location	ceiling/wall
Width	400 mm
Length	400 mm
Height	115 mm
Diameter	ø 400 mm
mounting holes (diameter)	3xø5mm
Installation wire (diameter)	2xø16mm
Energy Class	D
Impact strength	IK04
Operating temperature	from -20°C to +30°C

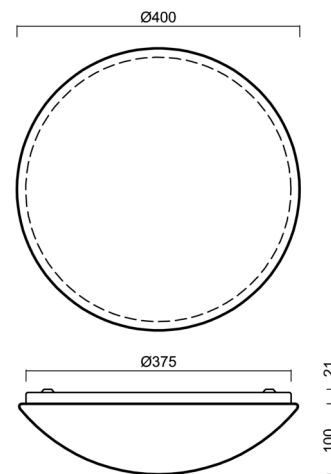

Electric

Power consumption	33 W
Ingress Protection	IP54
Socket	LED modul
terminal block	snap terminal block
Automatic circuit breaker type B10A	22 pcs
Automatic circuit breaker type B16A	36 pcs

Luminous

Lum. flux of luminaire	3510 lm
Lum. flux of light source	5090 lm
Luminaire efficacy	106 lm/W
Temperature	2700-6500 K
Rated life time LED L80/B10	100000 hours
CRI	Ra80
MacAdam	3
Blue light hazard	Risk group 0

Eulum data for calculation programs are available at www.osmont.cz.

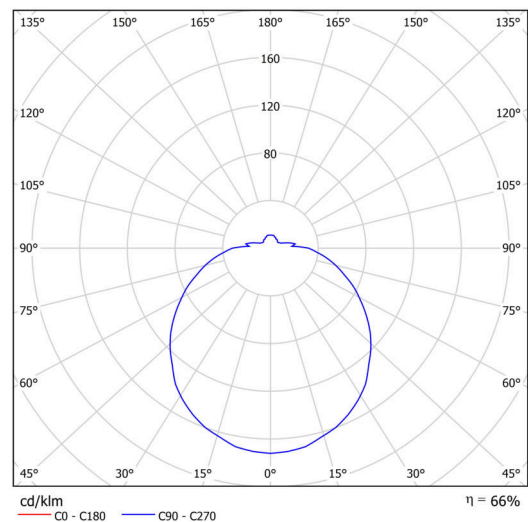

Logistic

EAN	8591728131326
Weight NTTO	1.8 Kg

TECHNICAL SHEET

Weight BTTO	2.2 Kg
Number of cartons	1 pcs
Package volume	0.02 m ³
Package 1 width	0.42 m
Package 1 length	0.405 m
Package 1 height	0.12 m
Warranty*	60 months

*The warranty for the batteries is valid for 12 months from the date of purchase.

Installation dimensions:

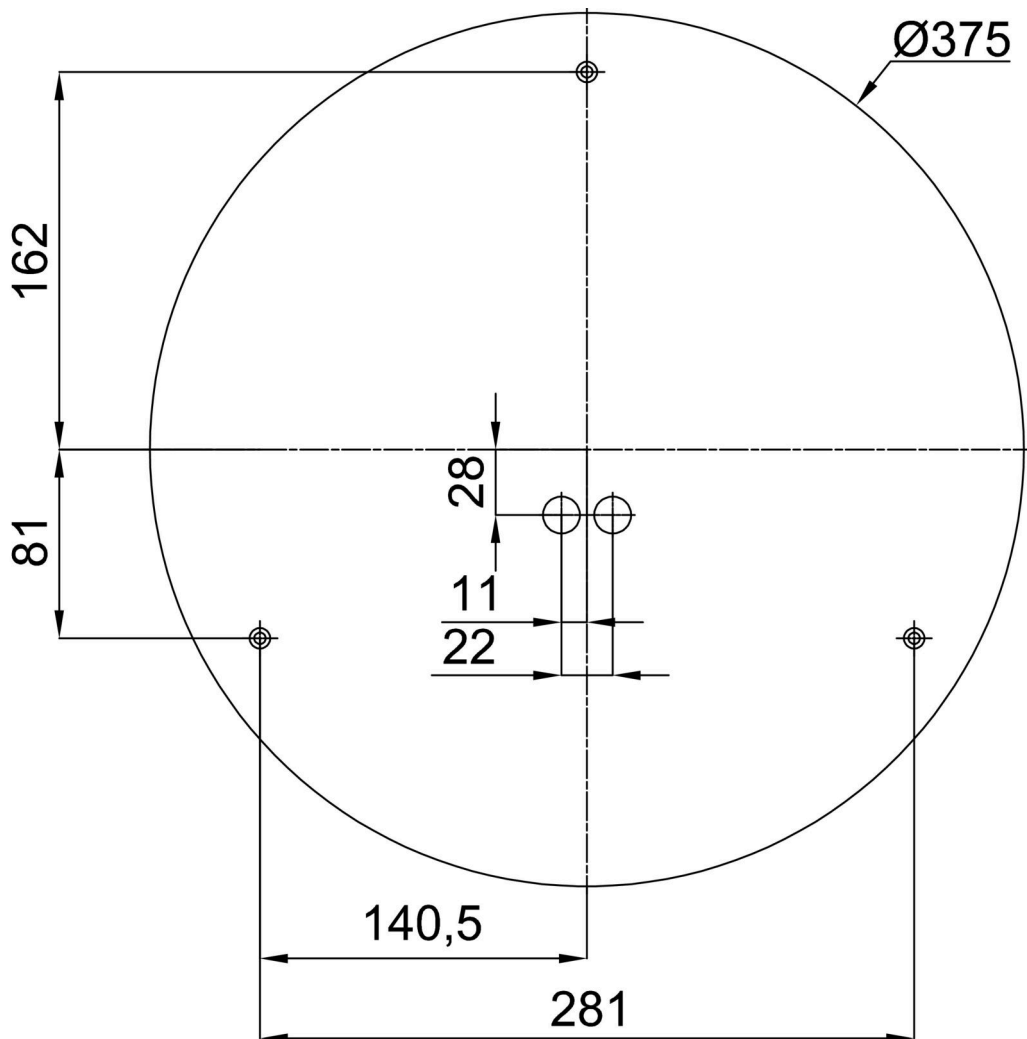

Additional assortment:

Base for surface mounting

Product code	Name	Color	Description	Picture	Drawing
33502	KN8,K8/BP	white Ra19003			

Lampshade

Product code	Name	Color	Description	Picture	Drawing
20508	PM08	white		