



TITAN 2

LED-1L16EMP700KN83/PM08 4K#

WWW.OSMONT.CZ

TITAN 2

Product code: TIT53767

Type: LED-1L16EMP700KN83/PM08 4K#

Short description of the luminaire: White surface-mounted LED light ON/OFF and PMMA shade.

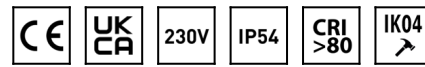

Technical

Types of luminaires	Classic on/off
Mounting type	surface mounted
Base material	steel
Shade material	opal polymethyl methacrylate
Base color	white Ra9003
Shade color	white
Holding the shade	folding system
Mounting location	ceiling/wall
Width	400 mm
Length	400 mm
Height	115 mm
Diameter	ø 400 mm
mounting holes (diameter)	3xø5mm
Installation wire (diameter)	2xø16mm
Energy Class	D
Impact strength	IK04
Operating temperature	from -20°C to +30°C

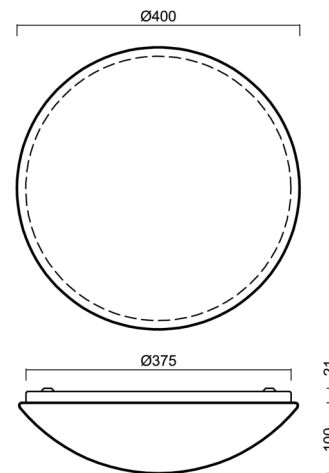

Electric

Power consumption	34 W
Ingress Protection	IP54
Socket	LED modul
terminal block	snap terminal block
Automatic circuit breaker type B10A	37 pcs
Automatic circuit breaker type B16A	59 pcs
Automatic circuit breaker type C10A	37 pcs
Automatic circuit breaker type C16A	59 pcs

Luminous

Lum. flux of luminaire	3640 lm
Lum. flux of light source	5270 lm
Luminaire efficacy	107 lm/W
Temperature	4000 K
Rated life time LED L80/B10	100000 hours
CRI	Ra80
MacAdam	3
Blue light hazard	Risk group 0

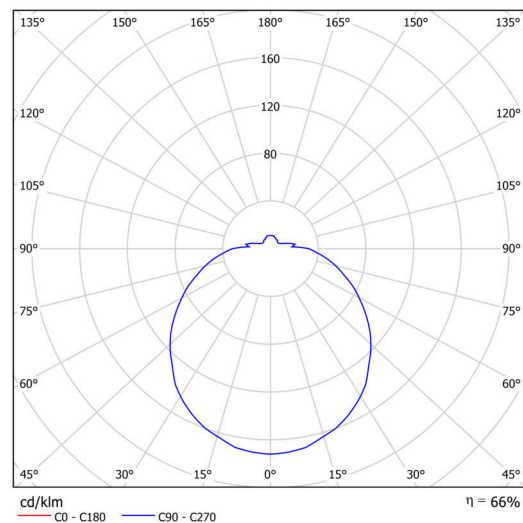

Eulum data for calculation programs are available at www.osmont.cz.

TECHNICAL SHEET



Multipower

Possibility of output adjustment by the user (DIP switch on the current source).

I [mA]	700	600	500	400	
[%]	100	86	71	57	

Logistic

EAN	8591728129972
Weight NTTO	1.8 Kg
Weight BTTO	2.2 Kg
Number of cartons	1 pcs
Package volume	0.02 m ³
Package 1 width	0.42 m
Package 1 length	0.405 m
Package 1 height	0.12 m
Warranty*	60 months

*The warranty for the batteries is valid for 12 months from the date of purchase.

Installation dimensions:

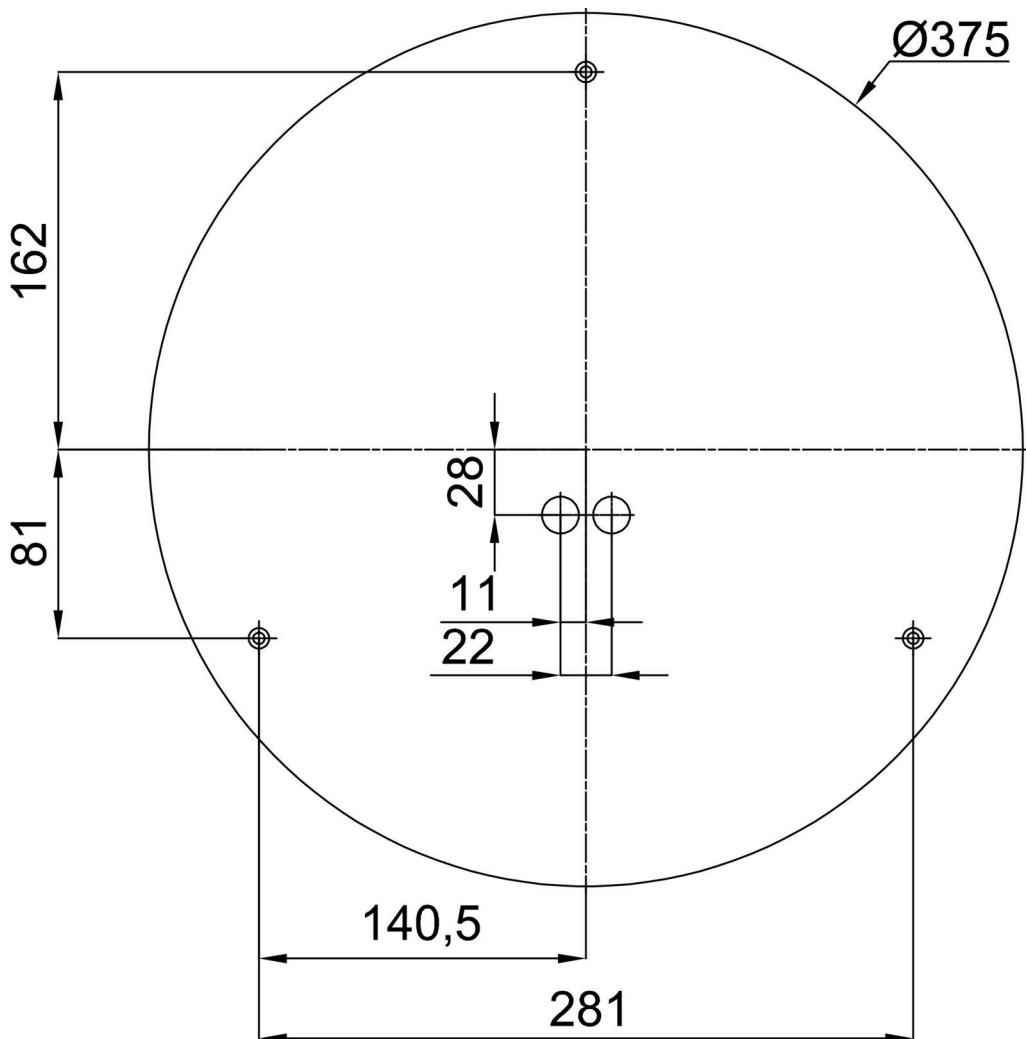

Additional assortment:

Base for surface mounting

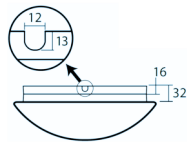
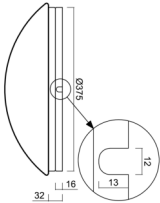
Product code	Name	Color	Description	Picture	Drawing
33502	KN8,K8/BP	white Ra19003			

Lampshade

Product code	Name	Color	Description	Picture	Drawing
20508	PM08	white		