



TITAN 1A

LED-1L12E500KN32/PM03 4K#

WWW.OSMONT.CZ

TITAN 1A

Product code: TIT56703

Type: LED-1L12E500KN32/PM03 4K#

Short description of the luminaire: White colour | ceiling or wall LED light ON/OFF | PMMA shade

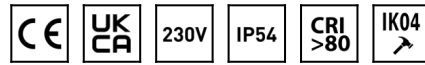

Technical

Types of luminaires	Classic on/off
Mounting type	surface mounted
Base material	steel
Shade material	opal polymethyl methacrylate
Base color	white Ra9003
Shade color	white
Holding the shade	folding system
Mounting location	ceiling/wall
Width	220 mm
Length	220 mm
Height	100 mm
Diameter	ø 220 mm
mounting holes (diameter)	3xø5mm
Cable entrance	2xø16mm
Energy Class	D
Impact strength	IK04
Operating temperature	from -20°C to +30°C

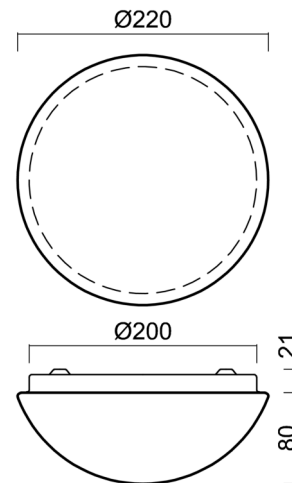

Electric

Power consumption	7 W
Ingress Protection	IP54
Socket	LED modul
terminal block	snap terminal block
Automatic circuit breaker type B10A	50 pcs
Automatic circuit breaker type B16A	78 pcs
Automatic circuit breaker type C10A	84 pcs
Automatic circuit breaker type C16A	130 pcs

Luminous

Lum. flux of luminaire	760 lm
Lum. flux of light source	1040 lm
Luminaire efficacy	108 lm/W
Temperature	4000 K
Rated life time LED L80/B10	100000 hours
CRI	Ra80
MacAdam	3
Blue light hazard	Risk group 0

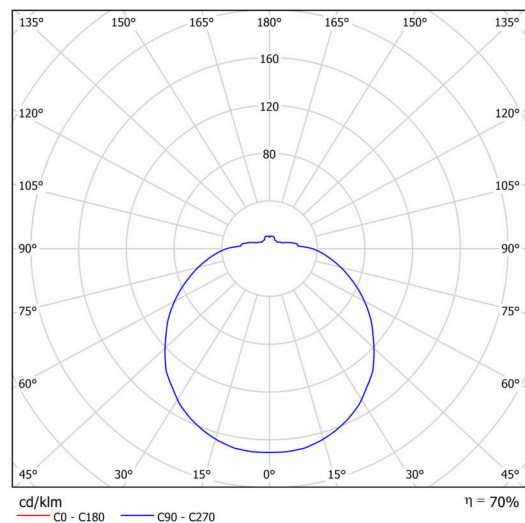

Eulum data for calculation programs are available at www.osmont.cz.

Logistic

EAN	8591728130640
Weight NTTO	0.7 Kg
Weight BTTO	0.9 Kg
Number of cartons	1 pcs
Package volume	0.006 m ³
Package 1 width	0.24 m
Package 1 length	0.23 m
Package 1 height	0.115 m
Warranty*	60 months

*The warranty for the batteries is valid for 12 months from the date of purchase.

Installation dimensions:

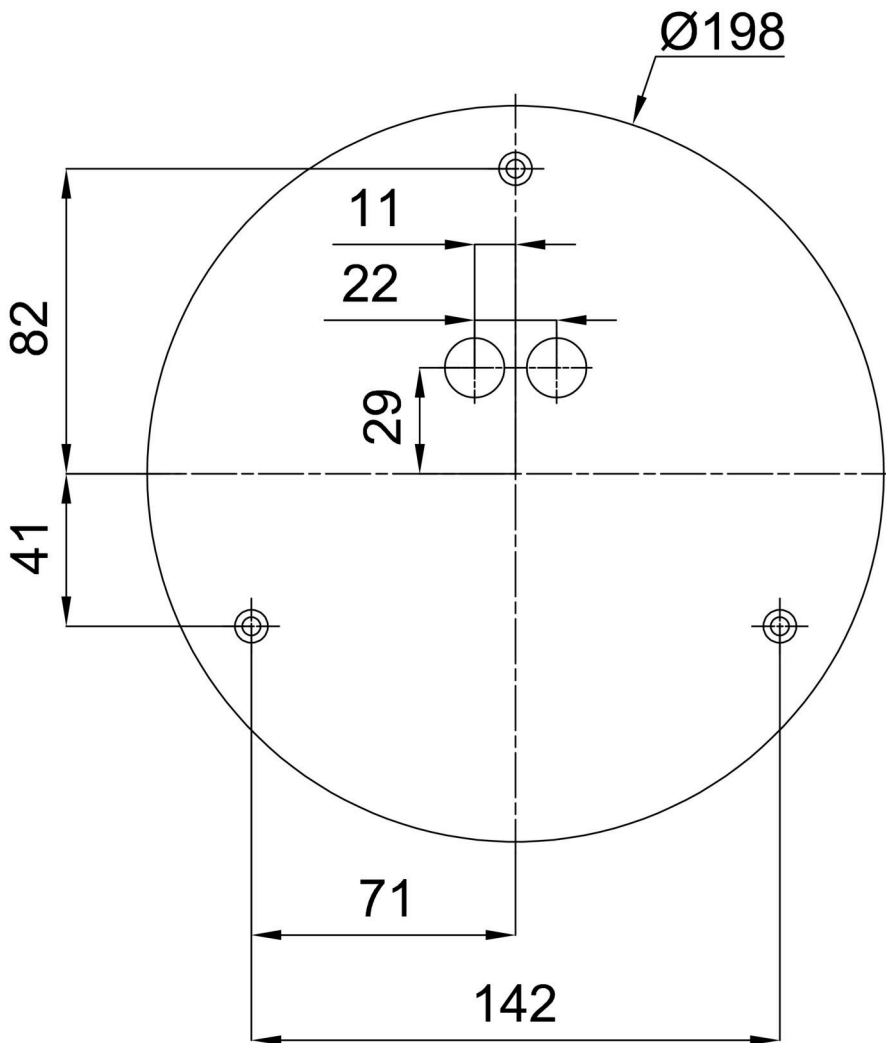

Additional assortment:

Base for surface mounting

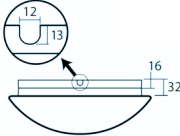
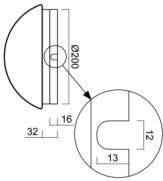
Product code	Name	Color	Description	Picture	Drawing
33500	KN3,B12/B P B	white Ral9003	příslušenství		

Lampshade

Product code	Name	Color	Description	Picture	Drawing
20514	PM03	white	příslušenství	