



TITAN 1

LED-1L14E500KN62/PC06 DALI 4K#

WWW.OSMONT.CZ

TITAN 1

Product code: TIT56708

Type: LED-1L14E500KN62/PC06 DALI 4K#

Short description of the luminaire: White surface-mounted LED light DALI and polycarbonate shade.

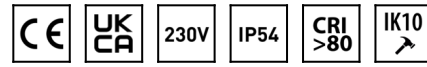

Technical

Types of luminaires	Dimmable
Mounting type	surface mounted
Base material	steel
Shade material	opal polycarbonate
Base color	white Ra9003
Shade color	white
Holding the shade	folding system
Mounting location	ceiling/wall
Width	300 mm
Length	300 mm
Height	105 mm
Diameter	ø 300 mm
mounting holes (diameter)	3xø4mm
Installation wire (diameter)	2xø16mm
Energy Class	D
Impact strength	IK10
Operating temperature	from -20°C to +30°C

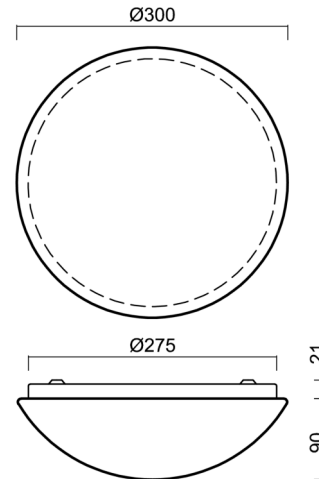

Electric

Power consumption	13 W
Ingress Protection	IP54
Socket	LED modul
terminal block	screwless
Automatic circuit breaker type B10A	31 pcs
Automatic circuit breaker type B16A	50 pcs
Automatic circuit breaker type C10A	52 pcs
Automatic circuit breaker type C16A	85 pcs

Luminous

Lum. flux of luminaire	1410 lm
Lum. flux of light source	2080 lm
Luminaire efficacy	108 lm/W
Temperature	4000 K
Rated life time LED L80/B10	100000 hours
CRI	Ra80
MacAdam	3
Blue light hazard	Risk group 0

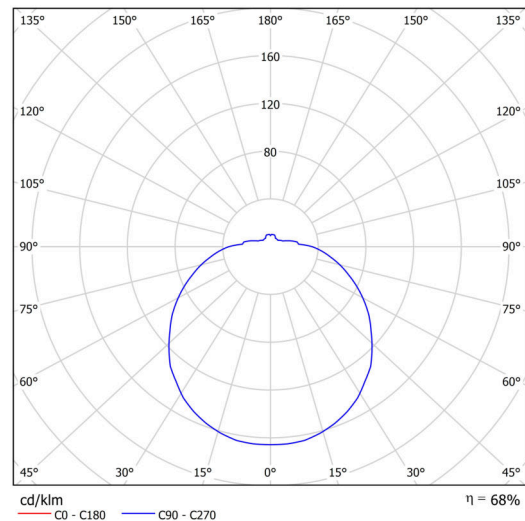

Eulum data for calculation programs are available at www.osmont.cz.

Logistic

EAN	8591728130695
Weight NTTO	0.9 Kg
Weight BTTO	1.1 Kg
Number of cartons	1 pcs
Package volume	0.011 m ³
Package 1 width	0.3 m
Package 1 length	0.285 m
Package 1 height	0.13 m
Warranty*	60 months

*The warranty for the batteries is valid for 12 months from the date of purchase.

Installation dimensions:



Additional assortment:

Base for surface mounting

Product code	Name	Color	Description	Picture	Drawing
33501	KN6,K6/BP	white Ra19003			

Lampshade

Product code	Name	Color	Description	Picture	Drawing
20504	PC06	white		