



SYLVIA 2

LED-2L25EMP700U12/130 DALI 4K##

WWW.OSMONT.CZ

SYLVIA 2

Product code: SYL51929

Type: LED-2L25EMP700U12/130 DALI 4K##

Short description of the luminaire: White color | surface-mounted LED light | dimmable DALI | TRIPLEX OPAL glass shade with matt surface



Technical

| | |
|------------------------------|--------------------------------|
| Types of luminaires | Dimmable |
| Mounting type | surface mounted |
| Base material | steel |
| Shade material | three-layer glass TRIPLEX OPAL |
| Base color | white Ral9003 |
| Shade color | white |
| Holding the shade | folding system |
| Mounting location | ceiling/wall |
| Width | 610 mm |
| Length | 105 mm |
| Height | 75 mm |
| mounting holes (diameter) | 2xØ5mm |
| Installation wire (diameter) | 2xØ16mm |
| Energy Class | D |
| Impact strength | IK01 |
| Operating temperature | from -20°C to +30°C |

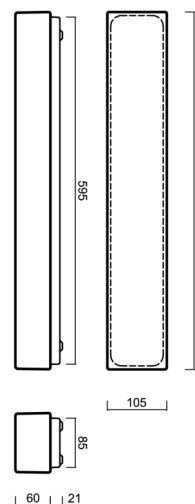

Electric

| | |
|-------------------------------------|---------------------|
| Power consumption | 18 W |
| Coverage class | 2 |
| Ingress Protection | IP44 |
| Socket | LED modul |
| terminal block | snap terminal block |
| Automatic circuit breaker type B10A | 31 pcs |
| Automatic circuit breaker type B16A | 50 pcs |
| Automatic circuit breaker type C10A | 52 pcs |
| Automatic circuit breaker type C16A | 85 pcs |

Luminous

| | |
|-----------------------------|--------------|
| Lum. flux of luminaire | 2000 lm |
| Lum. flux of light source | 2810 lm |
| Luminaire efficacy | 111 lm/W |
| Temperature | 4000 K |
| Rated life time LED L80/B10 | 100000 hours |
| CRI | Ra80 |
| MacAdam | 3 |
| Blue light hazard | Risk group 0 |

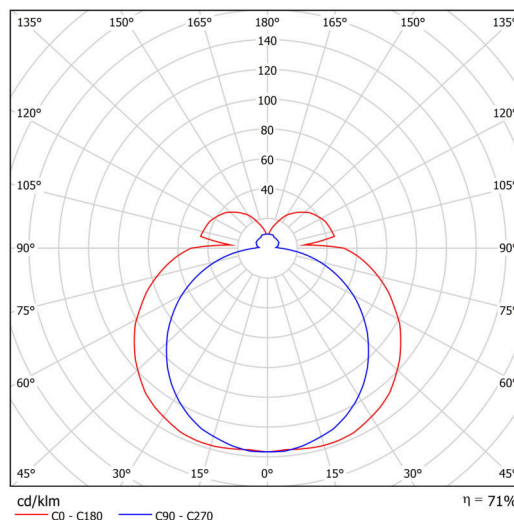

Eulum data for calculation programs are available at www.osmont.cz.

Logistic

| | |
|-------------------|----------------------|
| EAN | 8591728090142 |
| Weight NTTO | 2.8 Kg |
| Weight BTTO | 3 Kg |
| Number of cartons | 1 pcs |
| Package volume | 0.007 m ³ |
| Package 1 width | 0.655 m |
| Package 1 length | 0.125 m |
| Package 1 height | 0.085 m |
| Warranty* | 60 months |

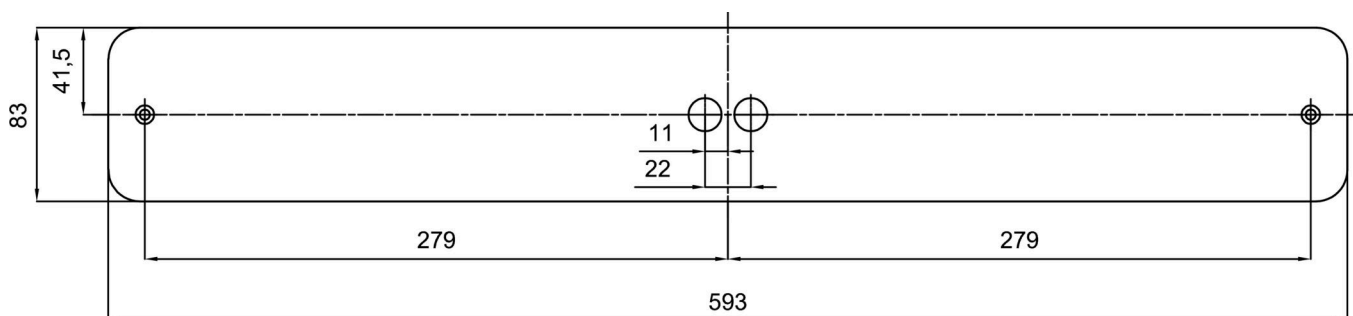

*The warranty for the batteries is valid for 12 months from the date of purchase.

Installation dimensions:



Additional assortment:

Decorative collar

| Product code | Name | Color | Description | Picture | Drawing |
|--------------|---------|--------------------------|--------------------------------|---|---------|
| 30145 | U12/X15 | brushed stainless steel | the collar is held by the base |  | |
| 30144 | U12/X14 | polished stainless steel | the collar is held by the base |  | |
| 30143 | U12/X4 | white Ral9003 | the collar is held by the base |  | |

Lampshade

| Product code | Name | Color | Description | Picture | Drawing |
|--------------|------|-------|-------------|--|---------|
| 20075 | 130 | white | |  | |