



SUBRA S6

LED-18L76/1L77E1050ZS/PM86/L100 B 3K##

WWW.OSMONT.CZ

SUBRA S6

Product code: SUB60020

Type: LED-18L76/1L77E1050ZS/PM86/L100 B 3K##

Short description of the luminaire: White color | pendant LED light | ON/OFF | PMMA shade

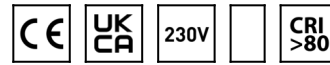

Technical

Types of luminaires	Classic on/off
Mounting type	Suspended - cable
Base material	steel
Shade material	opal polymethyl methacrylate
Base color	white Ra9003
Shade color	white
Holding the shade	screws
Mounting location	ceiling
Width	150 mm
Length	150 mm
Height	1510 mm
Diameter	ø 150 mm
Hinge length	1000 mm
mounting holes (diameter)	3xø5mm
Installation wire (diameter)	2xø16mm
Energy Class	D
Operating temperature	from -20°C to +30°C



Electric

Power consumption	120 W
Ingress Protection	IP20
Socket	LED modul
terminal block	snap terminal block
Automatic circuit breaker type B10A	10 pcs
Automatic circuit breaker type B16A	16 pcs
Automatic circuit breaker type C10A	17 pcs
Automatic circuit breaker type C16A	28 pcs

Luminous

Lum. flux of luminaire	15450 lm
Lum. flux of light source	19810 lm
Luminaire efficacy	128 lm/W
Temperature	3000 K
Rated life time LED L80/B10	100000 hours
CRI	Ra80
MacAdam	3
Blue light hazard	Risk group 0

Eulum data for calculation programs are available at www.osmont.cz.

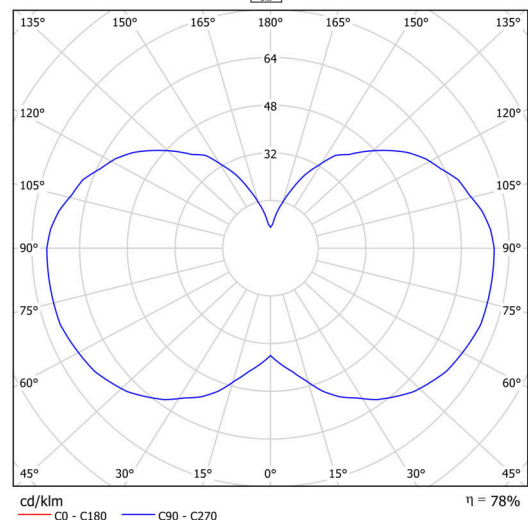

TECHNICAL SHEET



Logistic

EAN	8591728089832
Warranty*	60 months

*The warranty for the batteries is valid for 12 months from the date of purchase.

Installation dimensions:

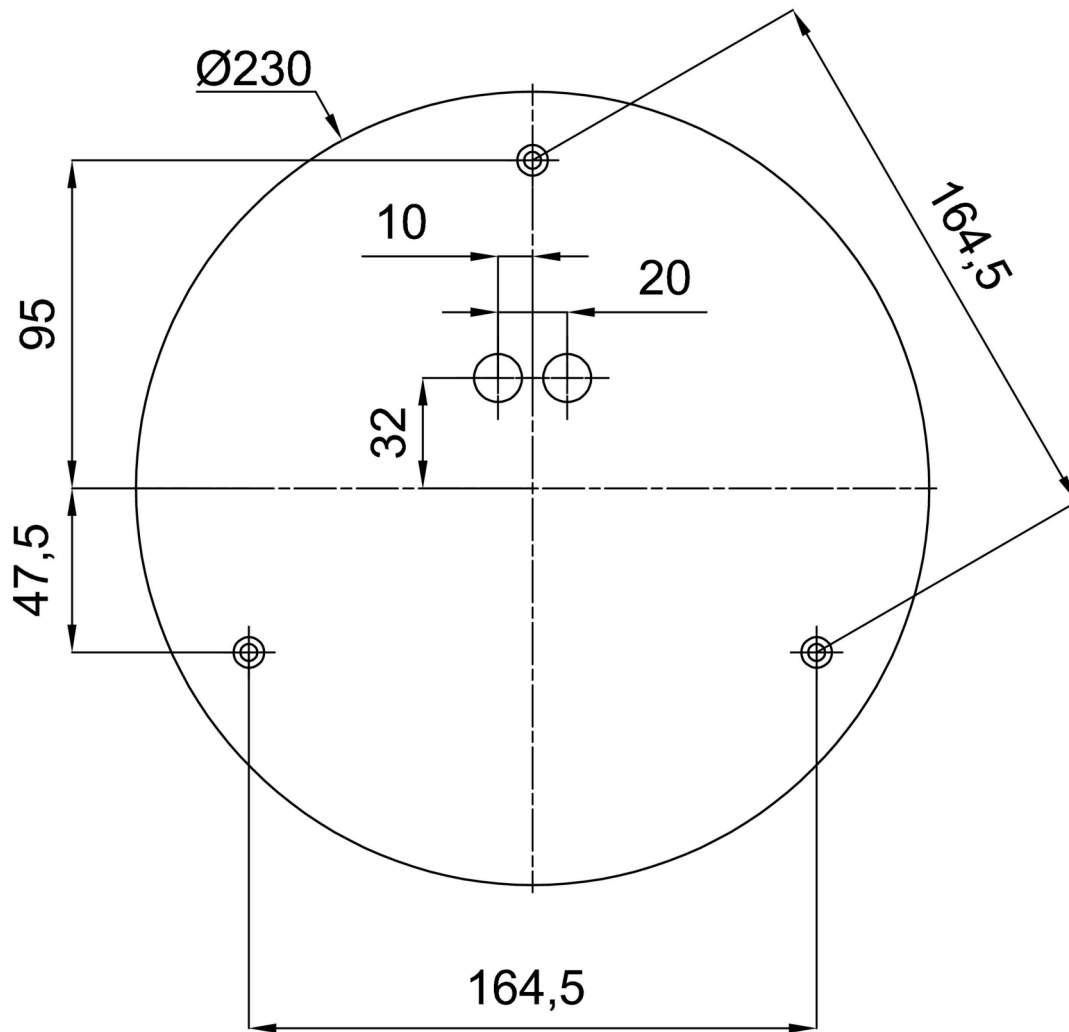

Additional assortment:

Lampshade

Product code	Name	Color	Description	Picture	Drawing
20665	PM86	white		