



SUBRA LH3

LED-18L71E1050ZLH/PM832/L100 B DALI 4K##

WWW.OSMONT.CZ

SUBRA LH3

Product code: SUB60557

Type: LED-18L71E1050ZLH/PM832/L100 B DALI 4K##

Short description of the luminaire: White colour | pendant LED light DALI | matt PMMA shade| steel wire pendant (with supply cable) 100 cm |

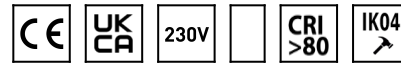

Technical data

Types of luminaires	Dimmable
Mounting type	Suspended - wire
Base material	steel
Shade material	opal polymethyl methacrylate
Base color	white Ral9003
Shade color	white
Holding the shade	screws
Mounting location	ceiling
Width	50 mm
Length	50 mm
Height	1505 mm
Suspension length	1000 mm
mounting holes (diameter)	2xØ5mm
Cable entrance	2xØ16mm
Energy Class	C
Impact strength	IK04
Operating temperature	from -20°C to +30°C



Electrical data

Power consumption	37 W
Ingress Protection	IP20
Socket	LED modul
terminal block	snap terminal block
Automatic circuit breaker type B10A	31 pcs
Automatic circuit breaker type B16A	50 pcs
Automatic circuit breaker type C10A	52 pcs
Automatic circuit breaker type C16A	85 pcs
Switching current	5 A / 50 µsec
Number of LED drivers	1

Luminous data

Lum. flux of luminaire	5160 lm
Lum. flux of light source	6610 lm
Luminaire efficacy	139 lm/W
Chromaticity temperature	4000 K
Rated life time LED L80/B10	100000 hours
CRI	Ra80
MacAdam	3
Blue light hazard	Risk group 0

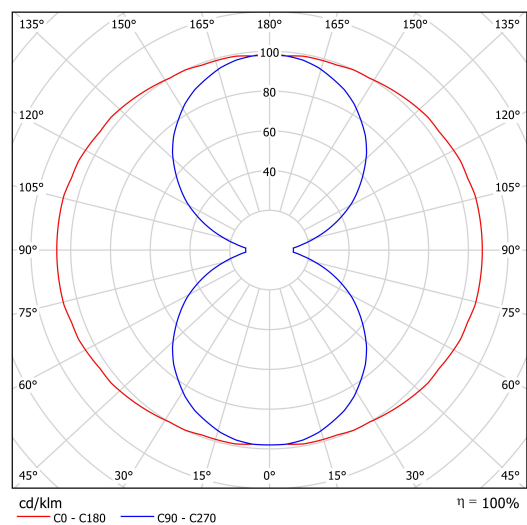

Eulum data for calculation programs are available at

OSMONT, s.r.o.
HYBRÁLEC 129,
586 01 JIHLAVA, CZ

Logistical data

EAN	8591728232801
Warranty*	60 months

*The warranty for the batteries is valid for 36 months from the date of purchase.

Installation dimensions:

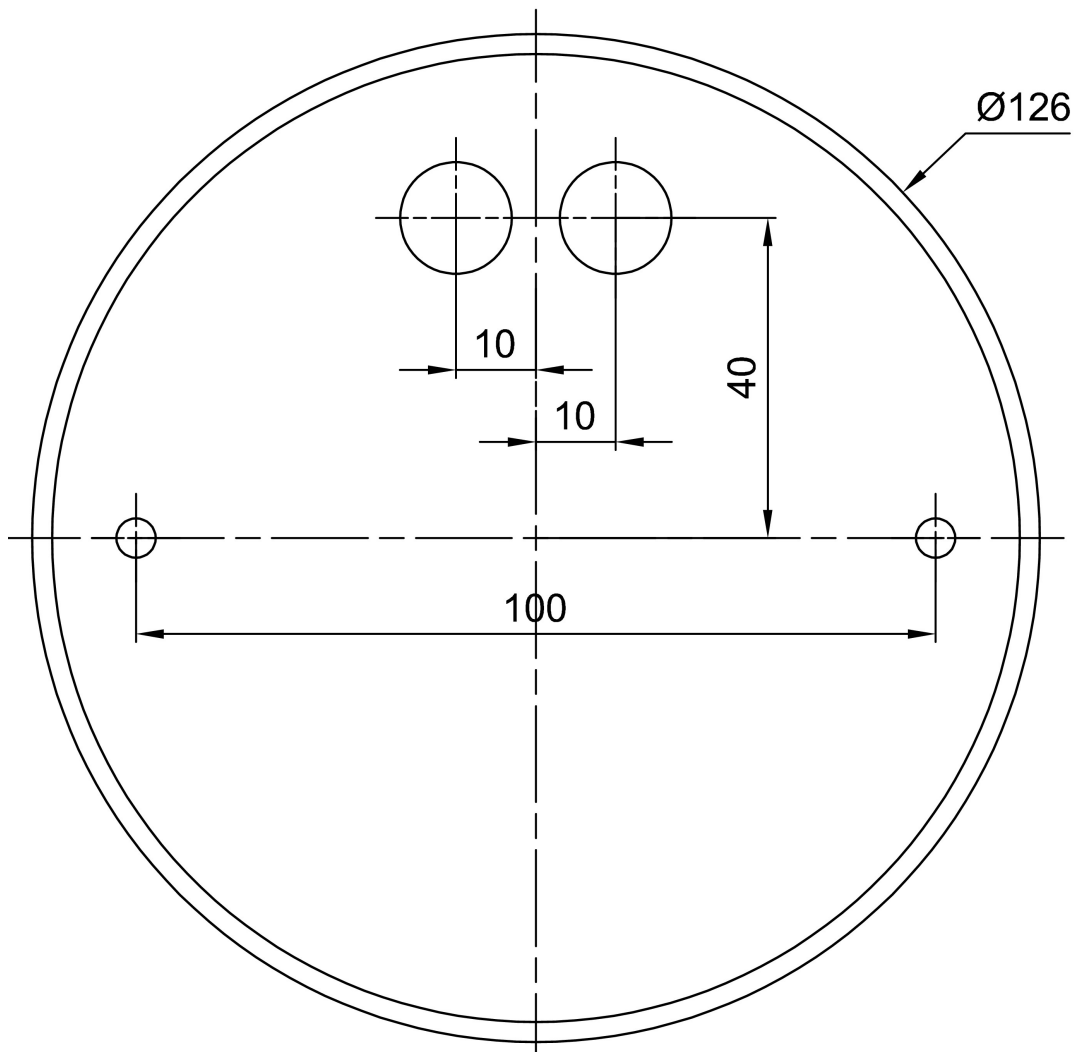

Additional assortment:

Lampshade

Product code	Name	Color	Picture	Drawing
20739	PM832 (pr.50/1505mm)	white	