



SKAT 2

LED-5L06E450BD1/PE02 S DALI 4K#

WWW.OSMONT.CZ

SKAT 2

Product code: SKA68920

Type: LED-5L06E450BD1/PE02 S DALI 4K#

Short description of the luminaire: Silver surface-mounted LED light DALI and polyethylene shade.

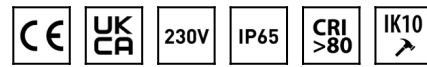

Technical

| | |
|------------------------------|---------------------|
| Types of luminaires | Dimmable |
| Mounting type | surface mounted |
| Base material | polycarbonate |
| Shade material | polyethylene |
| Base color | silver Ral9006 |
| Shade color | white |
| Holding the shade | bayonet |
| Mounting location | ceiling/wall |
| Width | 300 mm |
| Length | 300 mm |
| Height | 300 mm |
| Diameter | ø 300 mm |
| mounting holes (diameter) | 4xø5mm |
| Installation wire (diameter) | 2xø16mm |
| Energy Class | D |
| Impact strength | IK10 |
| Operating temperature | from -20°C to +30°C |

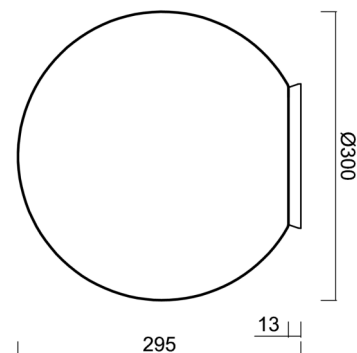

Electric

| | |
|-------------------------------------|----------------------|
| Power consumption | 20 W |
| Ingress Protection | IP65 |
| Socket | LED modul |
| terminal block | screw terminal block |
| Automatic circuit breaker type B10A | 31 pcs |
| Automatic circuit breaker type B16A | 50 pcs |
| Automatic circuit breaker type C10A | 52 pcs |
| Automatic circuit breaker type C16A | 85 pcs |

Luminous

| | |
|-----------------------------|--------------|
| Lum. flux of luminaire | 3090 lm |
| Lum. flux of light source | 3510 lm |
| Luminaire efficacy | 154 lm/W |
| Temperature | 4000 K |
| Rated life time LED L80/B10 | 100000 hours |
| CRI | Ra80 |
| MacAdam | 3 |
| Blue light hazard | Risk group 0 |

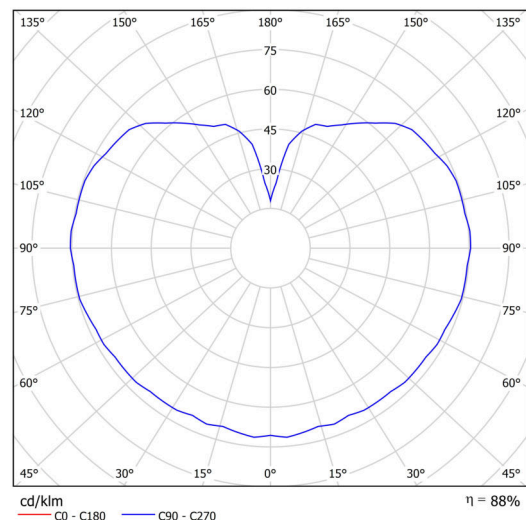

Eulum data for calculation programs are available at www.osmont.cz.

Logistic

| | |
|-------------------|----------------------|
| EAN | 8591728136505 |
| Weight NTTO | 2.7 Kg |
| Weight BTTO | 3 Kg |
| Number of cartons | 1 pcs |
| Package volume | 0.029 m ³ |
| Package 1 width | 0.31 m |
| Package 1 length | 0.31 m |
| Package 1 height | 0.305 m |
| Warranty* | 60 months |

*The warranty for the batteries is valid for 12 months from the date of purchase.

Installation dimensions:

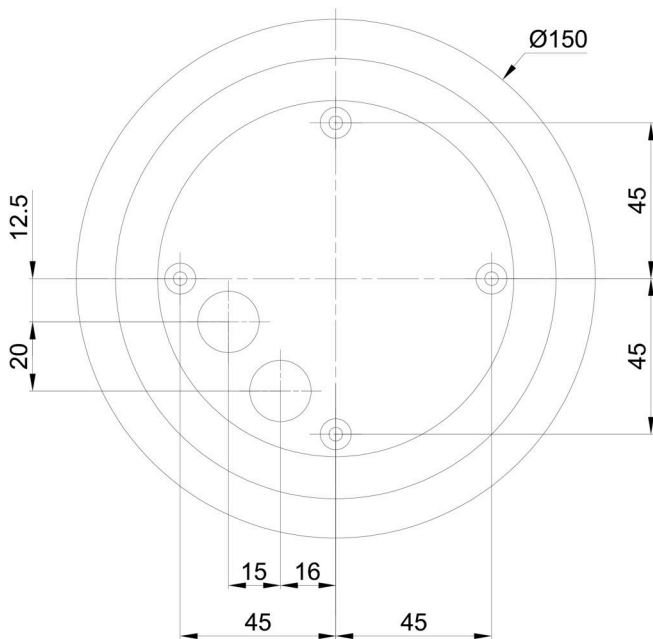

Additional assortment:

Base for surface mounting

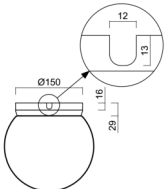
| Product code | Name | Color | Description | Picture | Drawing |
|--------------|------------|------------------|-------------|--|---|
| 33521 | BD1/BP 2-1 | white Ral9003 | |  |  |

Lampshade

| Product code | Name | Color | Description | Picture | Drawing |
|--------------|------|-------|-------------|--|---------|
| 20596 | PE02 | white | |  | |