



SADIRA 2

LED-1L14E350BD13/PC67/NK1W 3K#

WWW.OSMONT.CZ

SADIRA 2

Product code: SAD60004

Type: LED-1L14E350BD13/PC67/NK1W 3K#

Short description of the luminaire: White color | surface-mounted LED light | emergency combi unit | polycarbonate shade



Technical

Types of luminaires	Emergency combined
Mounting type	surface mounted
Base material	polypropylene composite
Shade material	opal polycarbonate
Base color	white Ra9003
Shade color	white
Holding the shade	bayonet
Mounting location	ceiling/wall
Width	296 mm
Length	296 mm
Height	76 mm
Diameter	Ø 296 mm
mounting holes (diameter)	3xØ5mm
Installation wire (diameter)	2xØ16mm
Energy Class	D
Impact strength	IK10
Operating temperature	from 0°C to +30°C

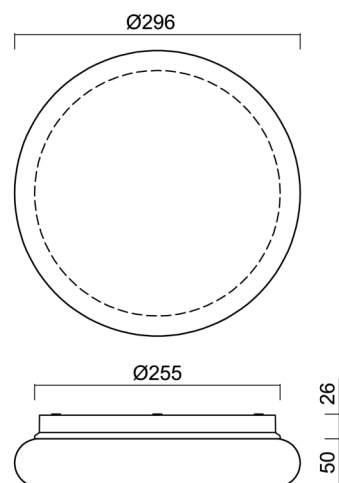

Electric

Power consumption	9 W
Ingress Protection	IP65
Socket	LED modul
Battery type	NiCd
Emergency time	3 hours
terminal block	snap terminal block
Automatic circuit breaker type B10A	32 pcs
Automatic circuit breaker type B16A	48 pcs
Automatic circuit breaker type C10A	57 pcs
Automatic circuit breaker type C16A	86 pcs

Luminous

Lum. flux of luminaire	1050 lm
Lum. flux of light source	1420 lm
Luminaire efficacy	116 lm/W
Temperature	3000 K
Rated life time LED L80/B10	100000 hours
CRI	Ra80
MacAdam	3
Blue light hazard	Risk group 0

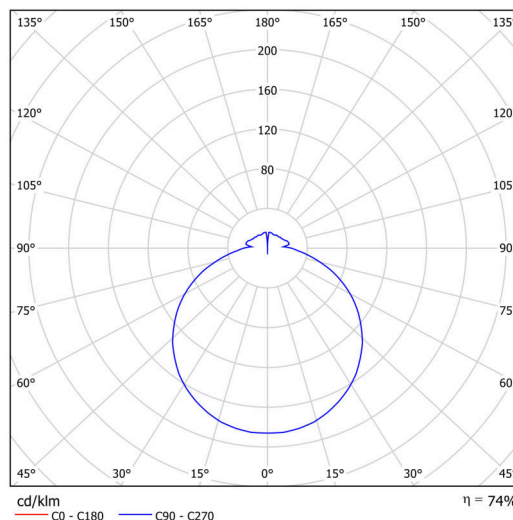

Eulum data for calculation programs are available at www.osmont.cz.

TECHNICAL SHEET



Logistic

EAN	8591728089207
Weight NTTO	0.6 Kg
Weight BTTO	0.9 Kg
Warranty*	60 months

*The warranty for the batteries is valid for 12 months from the date of purchase.

Installation dimensions:

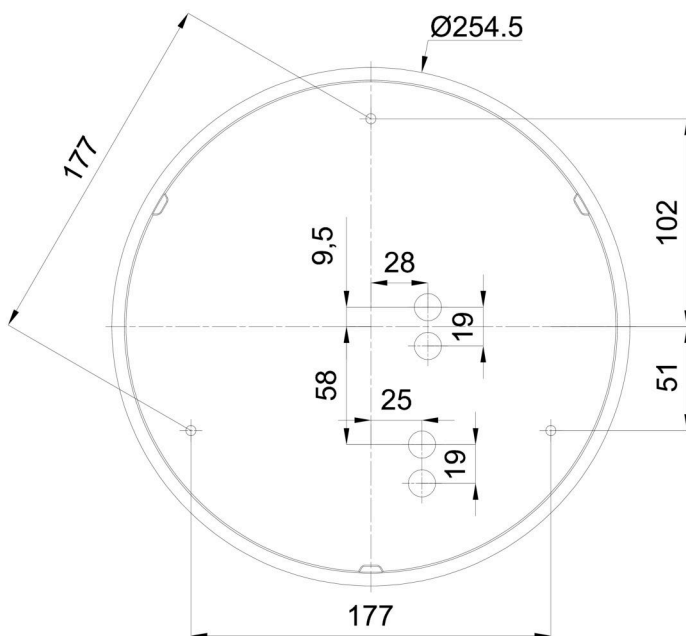

Additional assortment:

Lampshade

Product code	Name	Color	Description	Picture	Drawing
20625	PC67	white		