



NELA DL2

LED-1L41E700U7/264/DL15 HF 4K#

WWW.OSMONT.CZ

NELA DL2

Product code: NEL59958

Type: LED-1L41E700U7/264/DL15 HF 4K#

Short description of the luminaire: Stainless brushed surface-mounted LED light with sensor with TRIPLEX OPAL glass shade.



Technical

Types of luminaires	Sensor
Mounting type	surface mounted
Base material	stainless steel steel
Shade material	three-layer glass TRIPLEX OPAL
Base color	brushed stainless steel
Shade color	white
Holding the shade	screws
Mounting location	wall
Width	350 mm
Length	190 mm
Height	150 mm
mounting holes (diameter)	3xØ5mm
Installation wire (diameter)	2xØ16mm
Energy Class	D
Impact strength	IK01
Operating temperature	from -20°C to +30°C

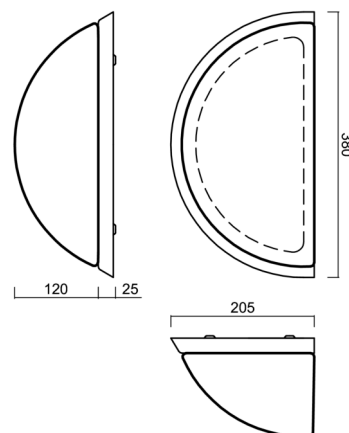

Electric

Power consumption	13 W
Ingress Protection	IP43
Socket	LED modul
Sensor	HF
terminal block	snap terminal block
Automatic circuit breaker type B10A	31 pcs
Automatic circuit breaker type B16A	50 pcs
Automatic circuit breaker type C10A	52 pcs
Automatic circuit breaker type C16A	85 pcs

Luminous

Lum. flux of luminaire	1370 lm
Lum. flux of light source	2110 lm
Luminaire efficacy	105 lm/W
Temperature	4000 K
Rated life time LED L80/B10	100000 hours
CRI	Ra80
MacAdam	3
Blue light hazard	Risk group 0

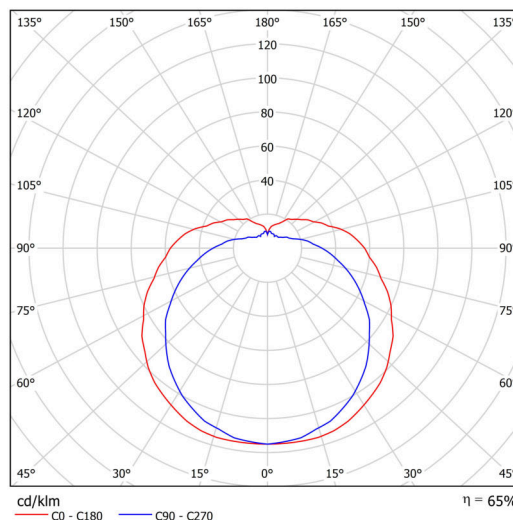

Eulum data for calculation programs are available at www.osmont.cz.

Logistic

EAN	8591728142131
Weight NTTO	2.7 Kg
Weight BTTO	2.9 Kg
Number of cartons	1 pcs
Package volume	0.014 m ³
Package 1 width	0.375 m
Package 1 length	0.235 m
Package 1 height	0.155 m
Warranty*	60 months

*The warranty for the batteries is valid for 12 months from the date of purchase.

Installation dimensions:

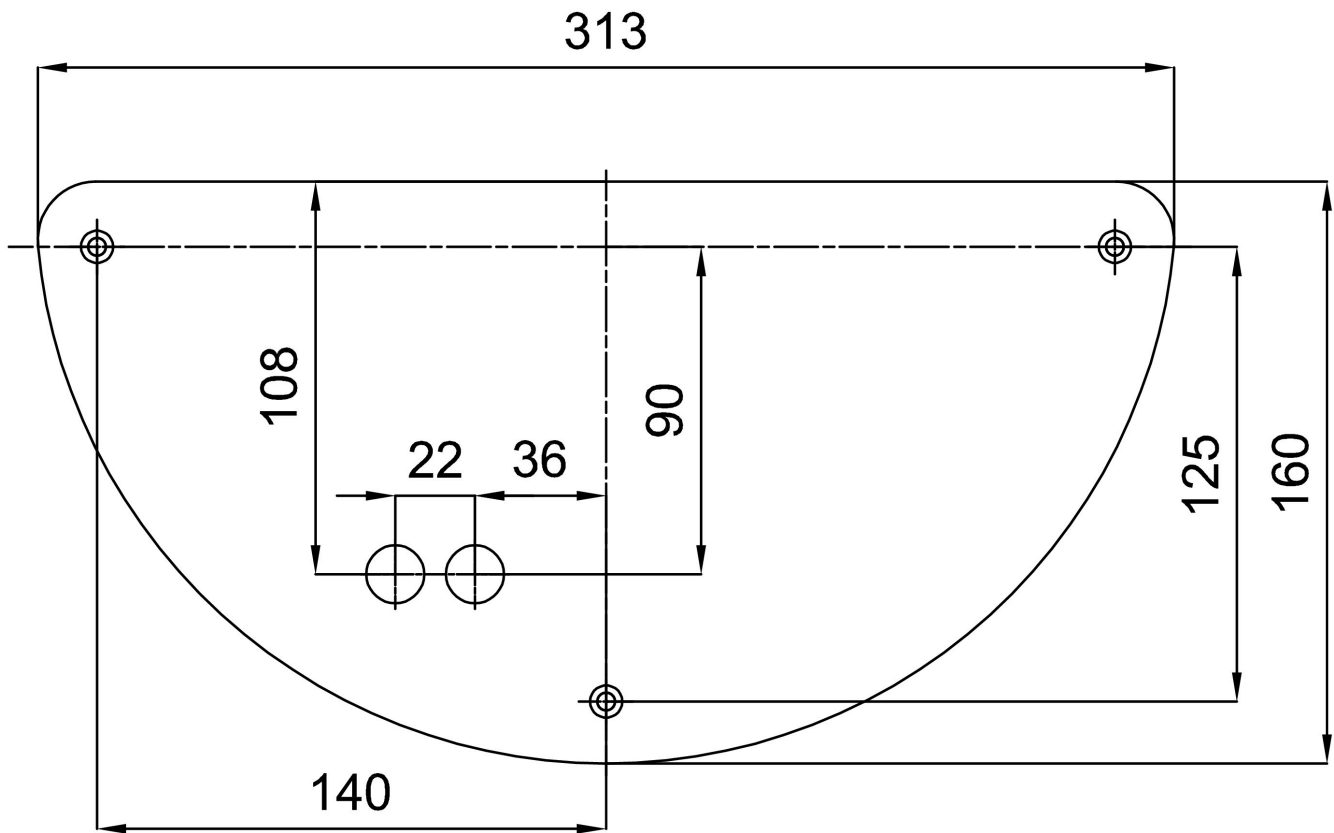

Additional assortment:

Lampshade

Product code	Name	Color	Description	Picture	Drawing
20021	264	white		