



NELA DL1

LED-1L26E700U5/244/DL14 4K#

WWW.OSMONT.CZ

NELA DL1

Product code: NEL59951

Type: LED-1L26E700U5/244/DL14 4K#

Short description of the luminaire: Stainless polished surface-mounted LED light ON/OFF with TRIPLEX OPAL glass shade.



Technical

Types of luminaires	Classic on/off
Mounting type	surface mounted
Base material	stainless steel steel
Shade material	three-layer glass TRIPLEX OPAL
Base color	polished stainless steel
Shade color	white
Holding the shade	screws
Mounting location	wall
Width	250 mm
Length	140 mm
Height	105 mm
mounting holes (diameter)	3xØ5mm
Installation wire (diameter)	2xØ16mm
Energy Class	D
Impact strength	IK01
Operating temperature	from -20°C to +30°C

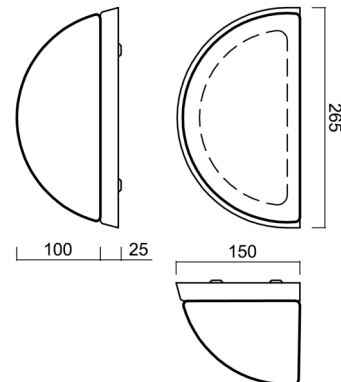

Electric

Power consumption	7 W
Ingress Protection	IP43
Socket	LED modul
terminal block	snap terminal block
Automatic circuit breaker type B10A	50 pcs
Automatic circuit breaker type B16A	78 pcs
Automatic circuit breaker type C10A	84 pcs
Automatic circuit breaker type C16A	130 pcs

Luminous

Lum. flux of luminaire	680 lm
Lum. flux of light source	1050 lm
Luminaire efficacy	97 lm/W
Temperature	4000 K
Rated life time LED L80/B10	100000 hours
CRI	Ra80
MacAdam	3
Blue light hazard	Risk group 0

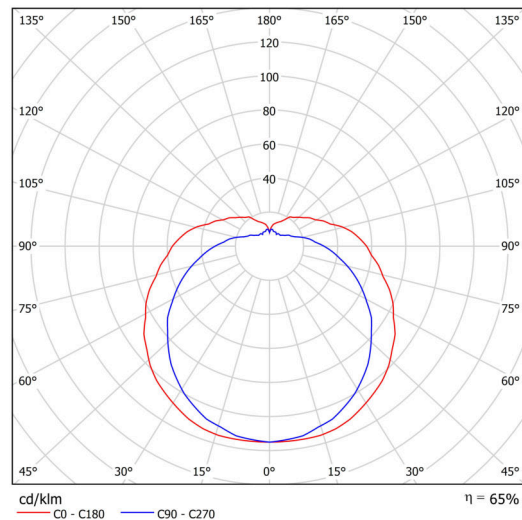

Eulum data for calculation programs are available at www.osmont.cz.

Logistic

EAN	8591728142063
Weight NTTO	1.6 Kg
Weight BTTO	1.7 Kg
Number of cartons	1 pcs
Package volume	0.005 m ³
Package 1 width	0.265 m
Package 1 length	0.145 m
Package 1 height	0.135 m
Warranty*	60 months

*The warranty for the batteries is valid for 12 months from the date of purchase.

Installation dimensions:

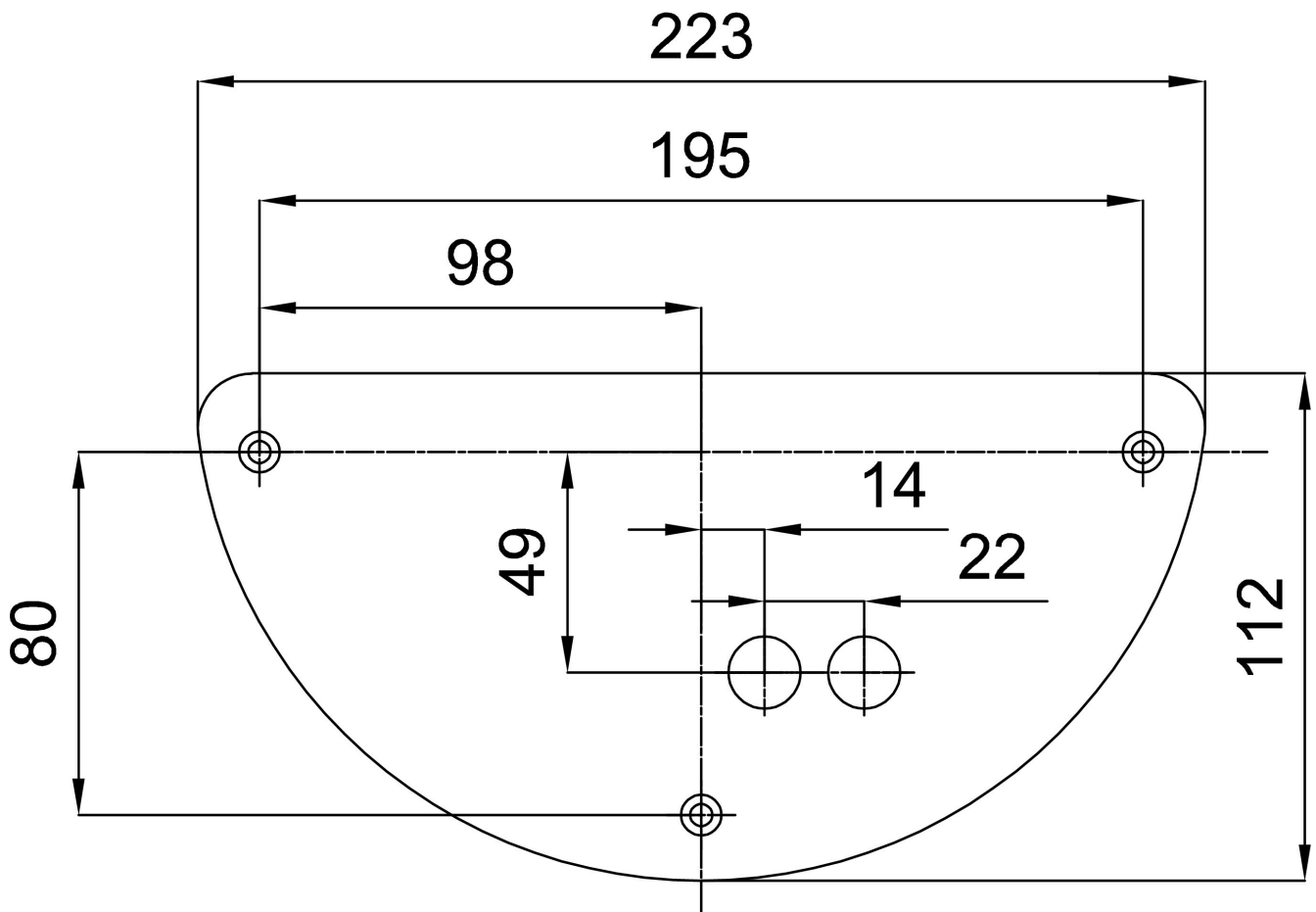

Additional assortment:

Lampshade

Product code	Name	Color	Description	Picture	Drawing
20020	244	white		