

NARA 2

LED-1L42E700U42/202 3K#

WWW.OSMONT.CZ

NARA 2

Product code: NAR48184

Type: LED-1L42E700U42/202 3K#

Short description of the luminaire: White surface-mounted LED light ON/OFF with TRIPLEX OPAL glass shade.



Technical

Types of luminaires	Classic on/off
Mounting type	surface mounted
Base material	steel
Shade material	three-layer glass TRIPLEX OPAL
Base color	white Ral9003
Shade color	white
Holding the shade	folding system
Mounting location	wall
Width	438 mm
Length	230 mm
Height	90 mm
mounting holes (diameter)	4xØ5mm
Installation wire (diameter)	2xØ16mm
Energy Class	D
Impact strength	IK01
Operating temperature	from -20°C to +30°C

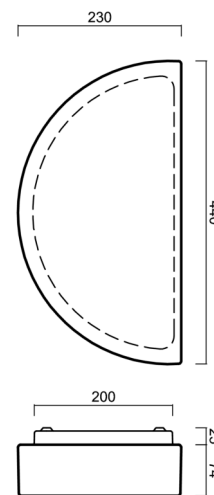

Electric

Power consumption	18 W
Ingress Protection	IP43
Socket	LED modul
terminal block	snap terminal block
Automatic circuit breaker type B10A	37 pcs
Automatic circuit breaker type B16A	59 pcs
Automatic circuit breaker type C10A	37 pcs
Automatic circuit breaker type C16A	59 pcs

Luminous

Lum. flux of luminaire	1750 lm
Lum. flux of light source	2690 lm
Luminaire efficacy	97 lm/W
Temperature	3000 K
Rated life time LED L80/B10	100000 hours
CRI	Ra80
MacAdam	3
Blue light hazard	Risk group 0

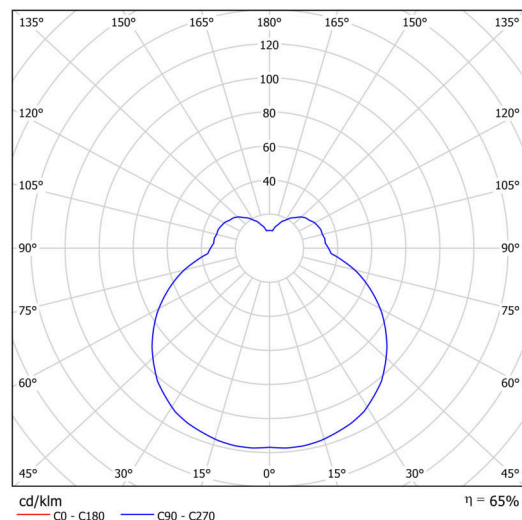

Eulum data for calculation programs are available at www.osmont.cz.

Logistic

EAN	8591728141660
Weight NTTO	3.05 Kg
Weight BTTO	3.4 Kg
Number of cartons	1 pcs
Package volume	0.016 m ³
Package 1 width	0.295 m
Package 1 length	0.445 m
Package 1 height	0.12 m
Warranty*	60 months

*The warranty for the batteries is valid for 12 months from the date of purchase.

Installation dimensions:

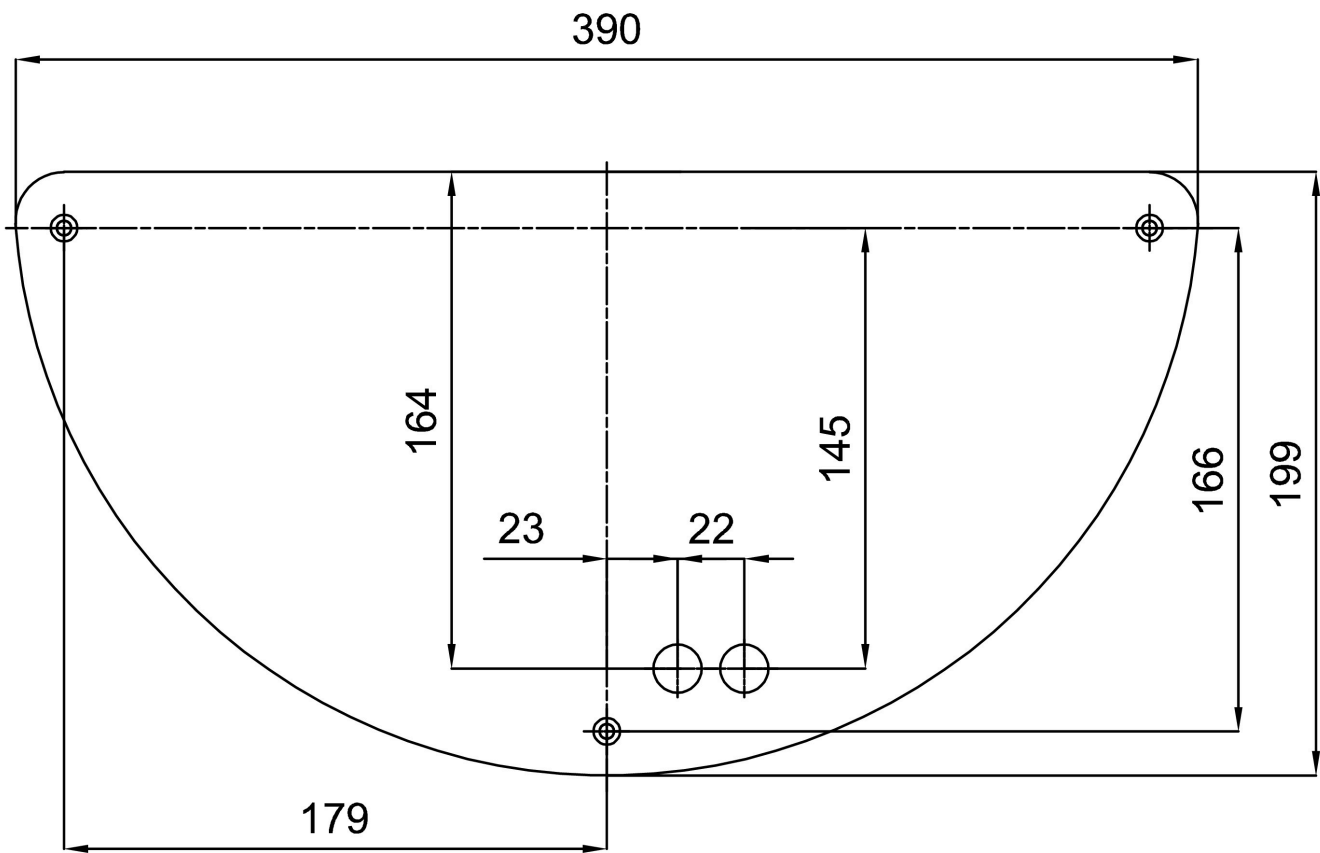

Additional assortment:

Lampshade

Product code	Name	Color	Description	Picture	Drawing
20106	202	white		