



LINA 6

LED-1L15E500K76/039 DALI 3/4K#

WWW.OSMONT.CZ

LINA 6

Product code: LIN71321

Type: LED-1L15E500K76/039 DALI 3/4K#

Short description of the luminaire: White surface-mounted changeable LED light DALI with TRIPLEX OPAL glass shade



Technical

Types of luminaires	Dimmable
Mounting type	surface mounted
Base material	steel
Shade material	three-layer glass TRIPLEX OPAL
Base color	white Ral9003
Shade color	white
Holding the shade	folding system
Mounting location	ceiling/wall
Width	380 mm
Length	380 mm
Height	120 mm
mounting holes (diameter)	4xØ5mm
Installation wire (diameter)	2xØ16mm
Energy Class	D
Impact strength	IK01
Operating temperature	from -20°C to +30°C

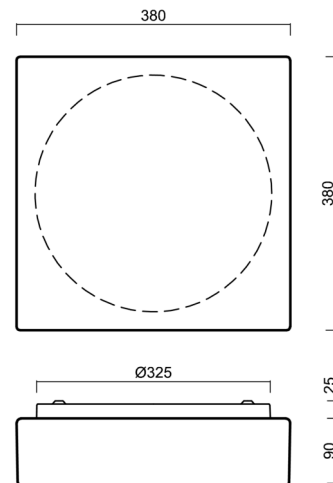

Electric

Power consumption	19 W
Ingress Protection	IP43
Socket	LED modul
terminal block	snap terminal block
Automatic circuit breaker type B10A	31 pcs
Automatic circuit breaker type B16A	50 pcs
Automatic circuit breaker type C10A	52 pcs
Automatic circuit breaker type C16A	85 pcs

Luminous

Lum. flux of luminaire	2040/2130 lm
Lum. flux of light source	3000/3130 lm
Luminaire efficacy	107 lm/W
Temperature	3000/4000 K
Rated life time LED L80/B10	100000 hours
CRI	Ra80
MacAdam	3
Blue light hazard	Risk group 0

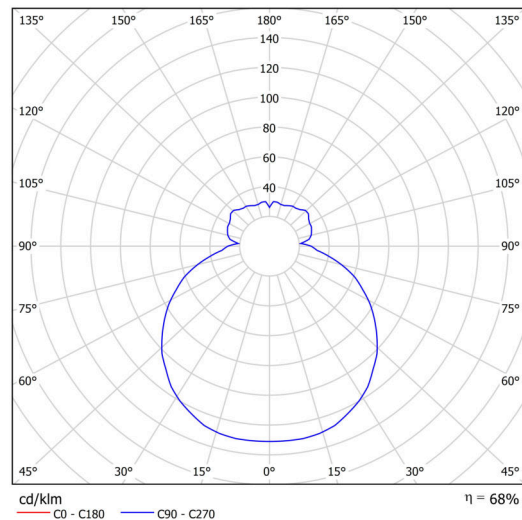

Eulum data for calculation programs are available at www.osmont.cz.

Logistic

EAN	8591728140434
Weight NTTO	4.8 Kg
Weight BTTO	5.2 Kg
Number of cartons	1 pcs
Package volume	0.021 m ³
Package 1 width	0.41 m
Package 1 length	0.39 m
Package 1 height	0.13 m
Warranty*	60 months

*The warranty for the batteries is valid for 12 months from the date of purchase.

Installation dimensions:

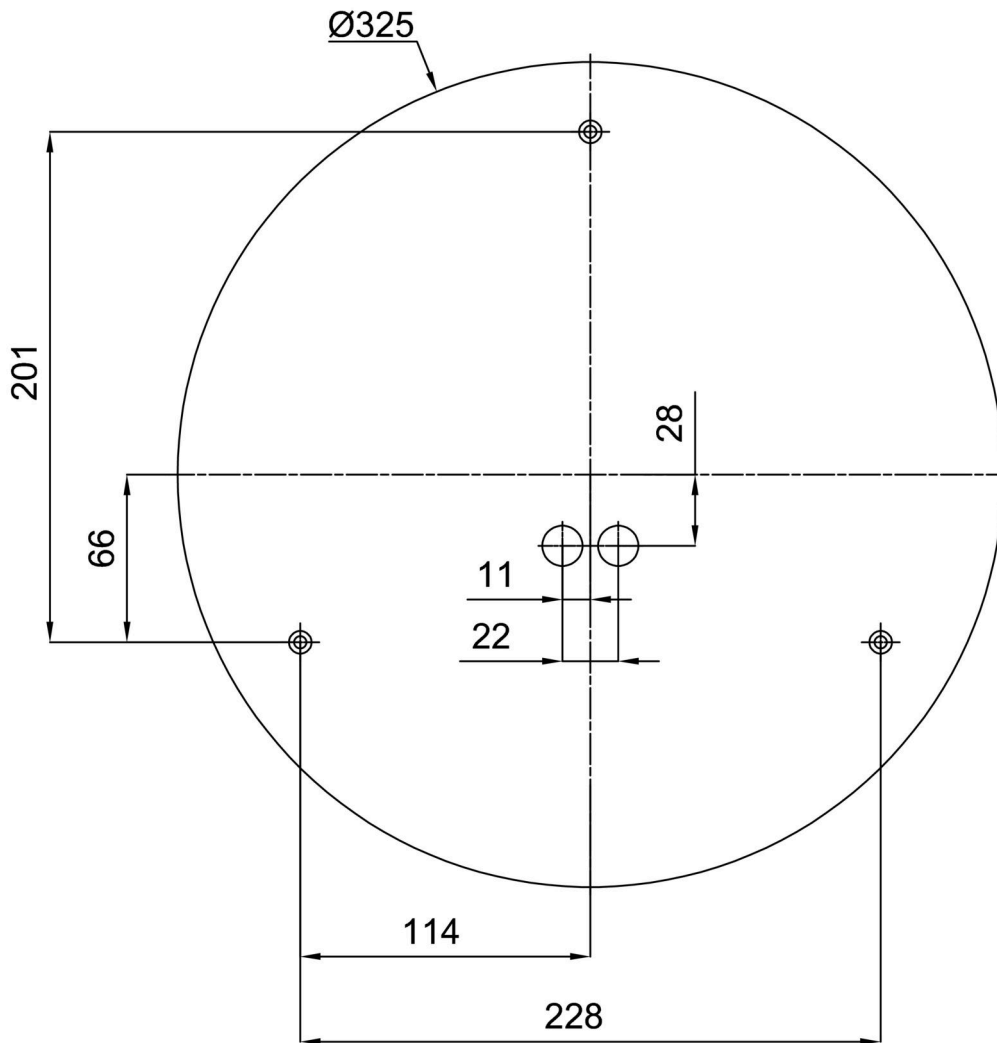

Additional assortment:

Lampshade

Product code	Name	Color	Description	Picture	Drawing
20053	039	white		