



## LINA 6

---

LED-1L15E500K76/039/NK1W HF 3K#

[WWW.OSMONT.CZ](http://WWW.OSMONT.CZ)

# LINA 6

Product code: LIN59201

Type: LED-1L15E500K76/039/NK1W HF 3K#

Short description of the luminaire: White surface-mounted LED light with emergency unit combined with sensor with TRIPLEX OPAL glass shade.



## Technical

|                              |                                |
|------------------------------|--------------------------------|
| Types of luminaires          | Emergency combined + sensor    |
| Mounting type                | surface mounted                |
| Base material                | steel                          |
| Shade material               | three-layer glass TRIPLEX OPAL |
| Base color                   | white Ral9003                  |
| Shade color                  | white                          |
| Holding the shade            | folding system                 |
| Mounting location            | ceiling/wall                   |
| Width                        | 380 mm                         |
| Length                       | 380 mm                         |
| Height                       | 120 mm                         |
| mounting holes (diameter)    | 4xØ5mm                         |
| Installation wire (diameter) | 2xØ16mm                        |
| Energy Class                 | D                              |
| Impact strength              | IK01                           |
| Operating temperature        | from -20°C to +30°C            |

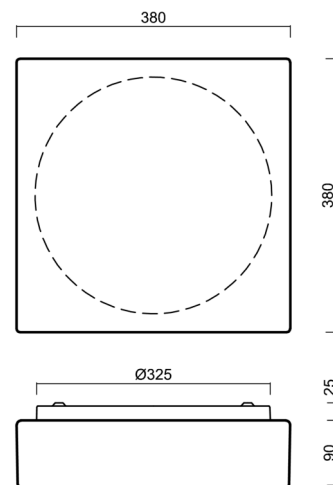

## Electric

|                                     |                     |
|-------------------------------------|---------------------|
| Power consumption                   | 19 W                |
| Ingress Protection                  | IP43                |
| Socket                              | LED modul           |
| Sensor                              | HF                  |
| Battery type                        | NiCd                |
| Emergency time                      | 3 hours             |
| terminal block                      | snap terminal block |
| Automatic circuit breaker type B10A | 26 pcs              |
| Automatic circuit breaker type B16A | 40 pcs              |
| Automatic circuit breaker type C10A | 30 pcs              |
| Automatic circuit breaker type C16A | 48 pcs              |

## Luminous

|   |              |
|---|--------------|
| Lum. flux of luminaire                      | 2040 lm      |
| Lum. flux of light source                   | 3000 lm      |
| Lum. flux of light source in emergency mode | 150 lm       |
| Luminaire efficacy                          | 107 lm/W     |
| Temperature                                 | 3000 K       |
| Rated life time LED L80/B10                 | 100000 hours |
| CRI   | Ra80         |
| MacAdam                                     | 3            |

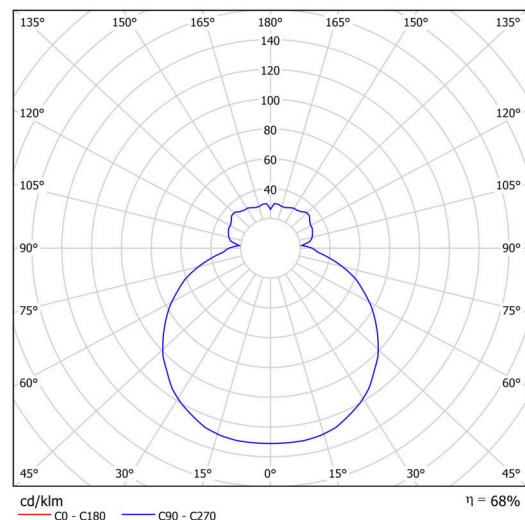

# TECHNICAL SHEET



|                   |              |
|-------------------|--------------|
| Blue light hazard | Risk group 0 |
|-------------------|--------------|

Eulum data for calculation programs are available at [www.osmont.cz](http://www.osmont.cz).

## Logistic

|                   |                      |
|-------------------|----------------------|
| EAN               | 8591728139612        |
| Weight NTTO       | 4.8 Kg               |
| Weight BTTO       | 5.2 Kg               |
| Number of cartons | 1 pcs                |
| Package volume    | 0.021 m <sup>3</sup> |
| Package 1 width   | 0.41 m               |
| Package 1 length  | 0.39 m               |
| Package 1 height  | 0.13 m               |
| Warranty*         | 60 months            |

\*The warranty for the batteries is valid for 12 months from the date of purchase.

## Installation dimensions:

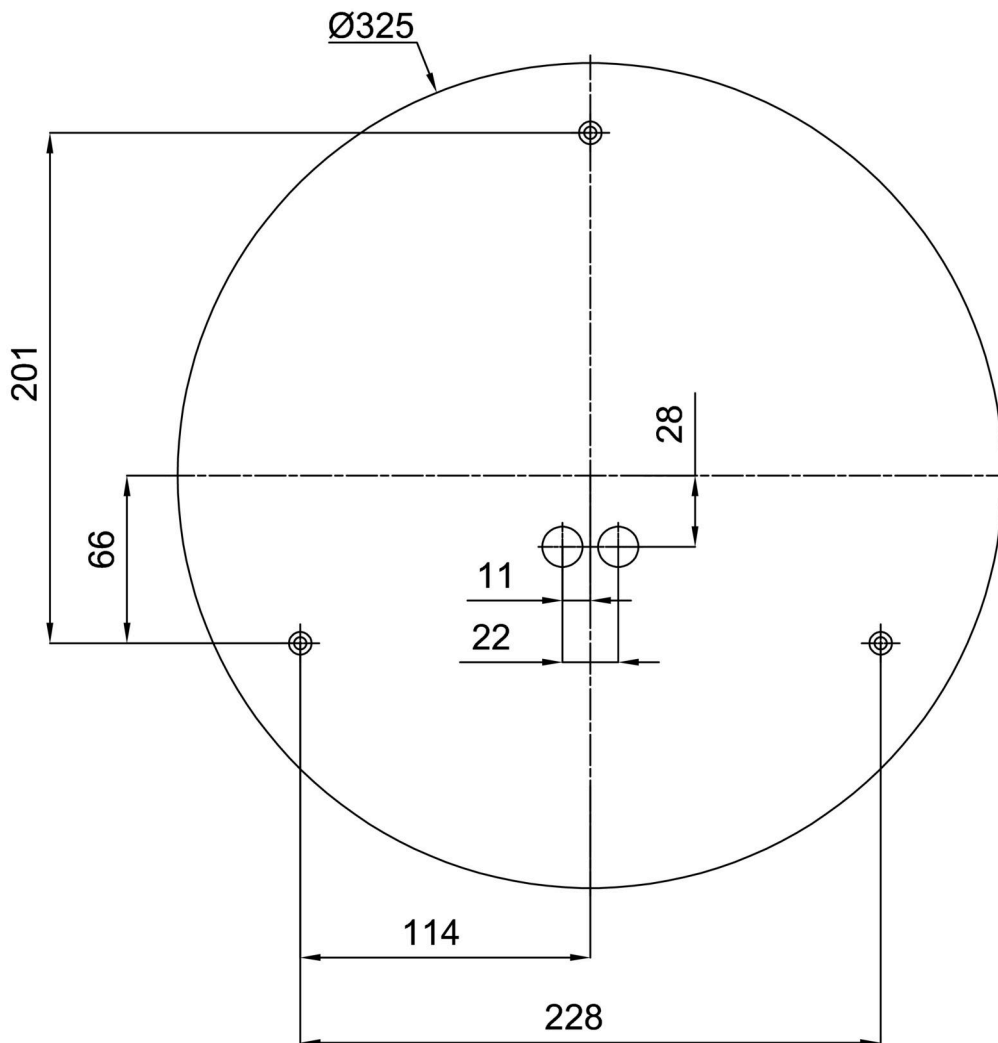

## Additional assortment:

## Lampshade

| Product code | Name | Color | Description | Picture  | Drawing |
|--------------|------|-------|-------------|--|---------|
| 20053        | 039  | white |             |  |         |