



LINA 3

LED-1L14E500K64/037/NK1W 4K#

WWW.OSMONT.CZ

LINA 3

Product code: LIN59687

Type: LED-1L14E500K64/037/NK1W 4K#

Short description of the luminaire: White surface-mounted LED light with emergency unit combined with TRIPLEX OPAL glass shade.

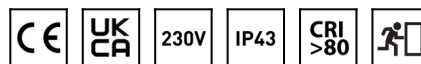

Technical

Types of luminaires	Emergency combined
Mounting type	surface mounted
Base material	steel
Shade material	three-layer glass TRIPLEX OPAL
Base color	white Ral9003
Shade color	white
Holding the shade	folding system
Mounting location	ceiling/wall
Width	320 mm
Length	320 mm
Height	115 mm
mounting holes (diameter)	4xØ5mm
Installation wire (diameter)	2xØ16mm
Energy Class	D
Impact strength	IK01
Operating temperature	from 0°C to +30°C

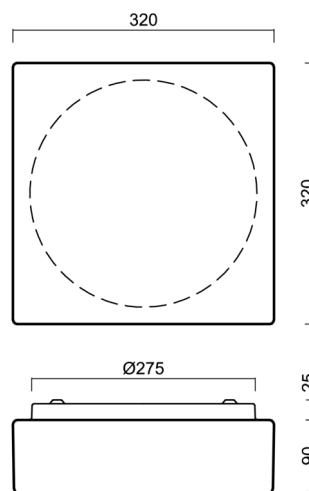

Electric

Power consumption	13 W
Ingress Protection	IP43
Socket	LED modul
Battery type	NiCd
Emergency time	3 hours
terminal block	snap terminal block
Automatic circuit breaker type B10A	26 pcs
Automatic circuit breaker type B16A	40 pcs
Automatic circuit breaker type C10A	30 pcs
Automatic circuit breaker type C16A	48 pcs

Luminous

Lum. flux of luminaire	1410 lm
Lum. flux of light source	2080 lm
Lum. flux of light source in emergency mode	150 lm
Luminaire efficacy	108 lm/W
Temperature	4000 K
Rated life time LED L80/B10	100000 hours
CRI	Ra80
MacAdam	3
Blue light hazard	Risk group 0

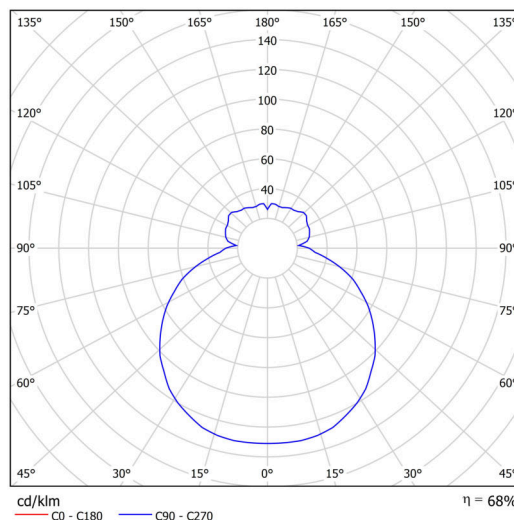

TECHNICAL SHEET



Eulum data for calculation programs are available at www.osmont.cz.

Logistic

EAN	8591728139827
Weight NTTO	3.3 Kg
Weight BTTO	3.6 Kg
Number of cartons	1 pcs
Package volume	0.017 m ³
Package 1 width	0.375 m
Package 1 length	0.355 m
Package 1 height	0.13 m
Warranty*	60 months

*The warranty for the batteries is valid for 12 months from the date of purchase.

Installation dimensions:

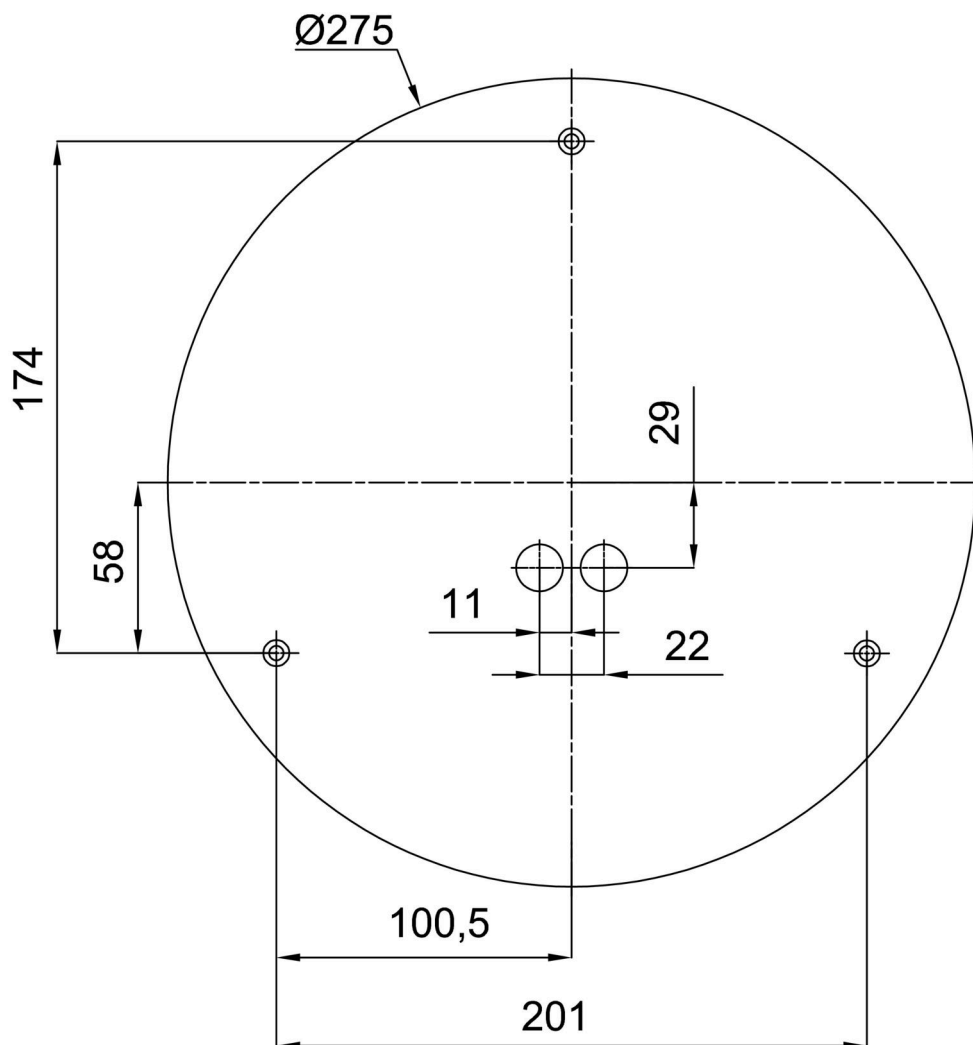

Additional assortment:

Lampshade

Product code	Name	Color	Description	Picture	Drawing
20014	037	white		