

KRUGER P3 FOP

LED-1L20EMP1050ZKN94/FOP3C/z5 C 4K#

WWW.OSMONT.CZ

KRUGER P3 FOP

Product code: KRU60727

Type: LED-1L20EMP1050ZKN94/FOP3C/z5 C 4K#

Short description of the luminaire: Black color | pendant LED light | ON/OFF | multipower function | opal prismatic shade | decorative collar

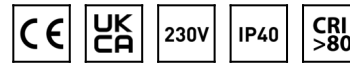

Technical

Types of luminaires	Classic on/off
Mounting type	Suspended - rod
Base material	steel
Shade material	Plastic opal prismatic (FOP) with metal collar
Base color	black Ral9005
Shade color	white - black
Holding the shade	folding system
Mounting location	ceiling
Width	490 mm
Length	490 mm
Height	80 mm
Diameter	ø 490 mm
Hinge length	1000 mm
mounting holes (diameter)	2xø5mm
Installation wire (diameter)	2xø16mm
Energy Class	D
Operating temperature	from -20°C to +30°C

Electric

Power consumption	48 W
Ingress Protection	IP40
Socket	LED modul
terminal block	screw terminal block
Automatic circuit breaker type B10A	24 pcs
Automatic circuit breaker type B16A	40 pcs
Automatic circuit breaker type C10A	24 pcs
Automatic circuit breaker type C16A	40 pcs

Luminous

Lum. flux of luminaire	4360 lm
Lum. flux of light source	8070 lm
Luminaire efficacy	90 lm/W
Temperature	4000 K
Rated life time LED L80/B10	100000 hours
CRI	Ra80
MacAdam	3
Blue light hazard	Risk group 0

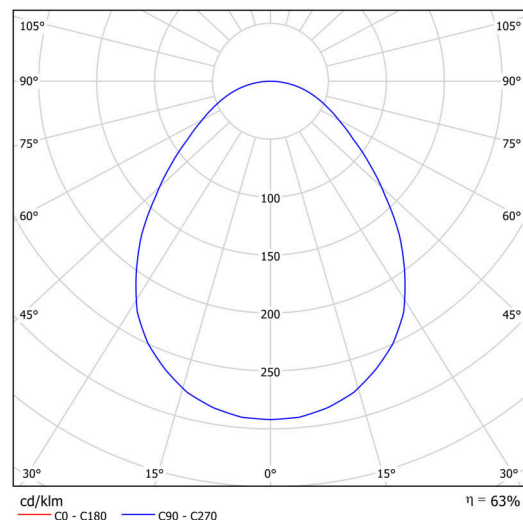
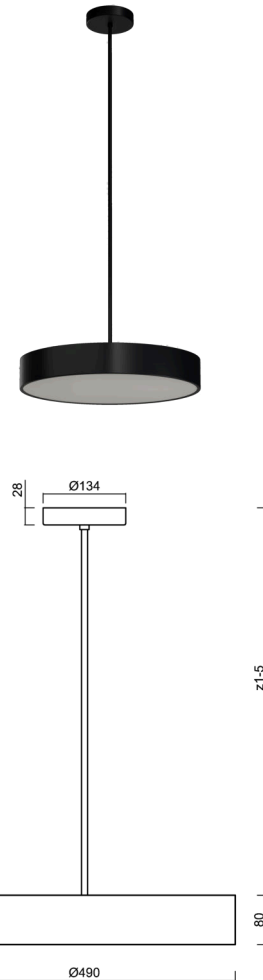

Eulum data for calculation programs are available at www.osmont.cz.

TECHNICAL SHEET



Multipower

Possibility of output adjustment by the user (DIP switch on the current source).

I [mA]	1050	900	850	700	
[%]	100	86	81	67	

Logistic

EAN	8591728085285
Warranty*	60 months

*The warranty for the batteries is valid for 12 months from the date of purchase.

Installation dimensions:

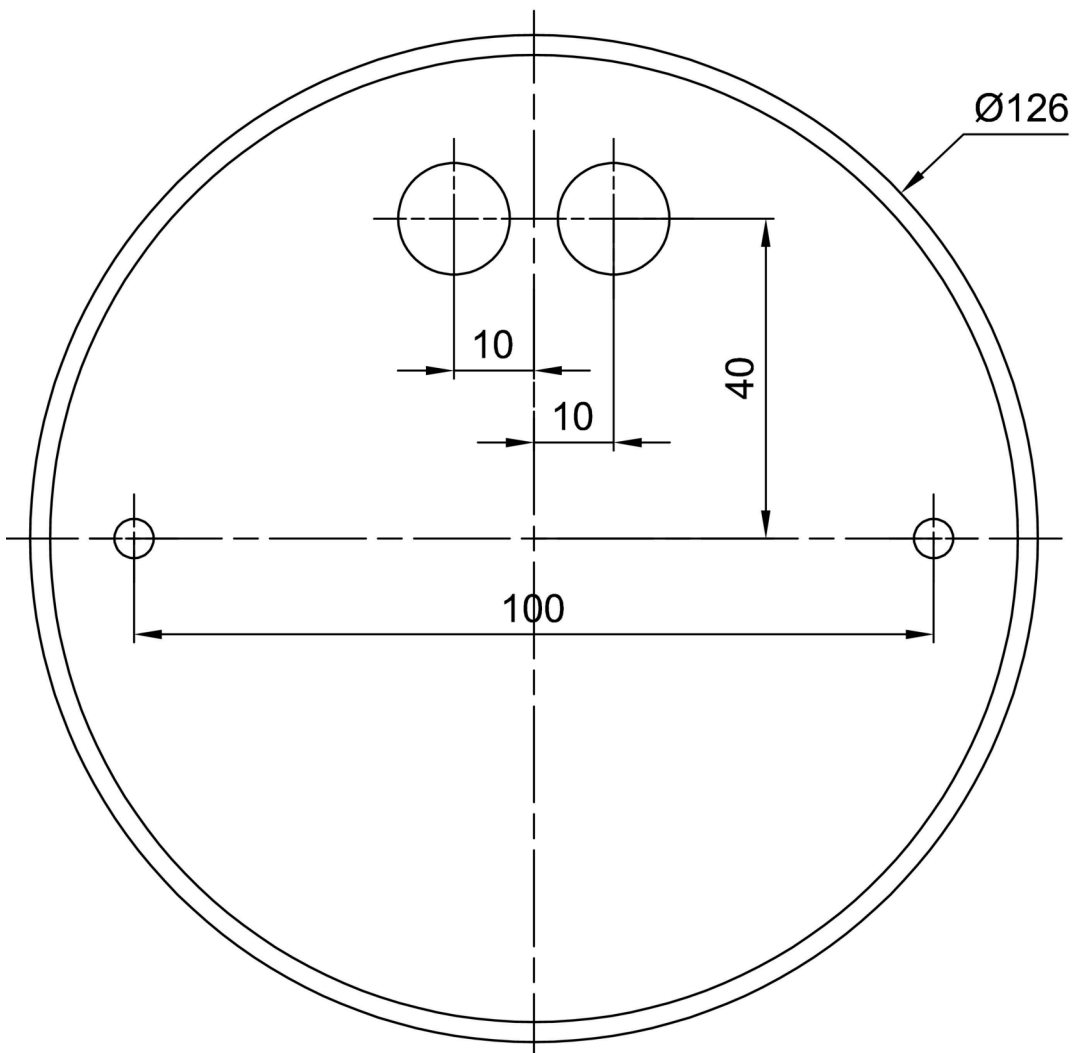

Additional assortment:

Lampshade

Product code	Name	Color	Description	Picture	Drawing
20647	FOP3C	white - black		