

KRUGER P3 FOP

LED-1L20EMP700ZKN94/FOP3B/z5 B 4K#

WWW.OSMONT.CZ

KRUGER P3 FOP

Product code: KRU60710

Type: LED-1L20EMP700ZKN94/FOP3B/z5 B 4K#

Short description of the luminaire: White color | pendant LED light | ON/OFF | multipower function | opal prismatic shade | decorative collar



Technical

Types of luminaires	Classic on/off
Mounting type	Suspended - rod
Base material	steel
Shade material	Plastic opal prismatic (FOP) with metal collar
Base color	white Ral9003
Shade color	white
Holding the shade	folding system
Mounting location	ceiling
Width	490 mm
Length	490 mm
Height	80 mm
Diameter	ø 490 mm
Hinge length	1000 mm
mounting holes (diameter)	2xø5mm
Installation wire (diameter)	2xø16mm
Energy Class	D
Operating temperature	from -20°C to +30°C

Electric

Power consumption	32 W
Ingress Protection	IP40
Socket	LED modul
terminal block	screw terminal block
Automatic circuit breaker type B10A	37 pcs
Automatic circuit breaker type B16A	59 pcs
Automatic circuit breaker type C10A	37 pcs
Automatic circuit breaker type C16A	59 pcs

Luminous

Lum. flux of luminaire	3390 lm
Lum. flux of light source	5560 lm
Luminaire efficacy	105 lm/W
Temperature	4000 K
Rated life time LED L80/B10	100000 hours
CRI	Ra80
MacAdam	3
Blue light hazard	Risk group 0

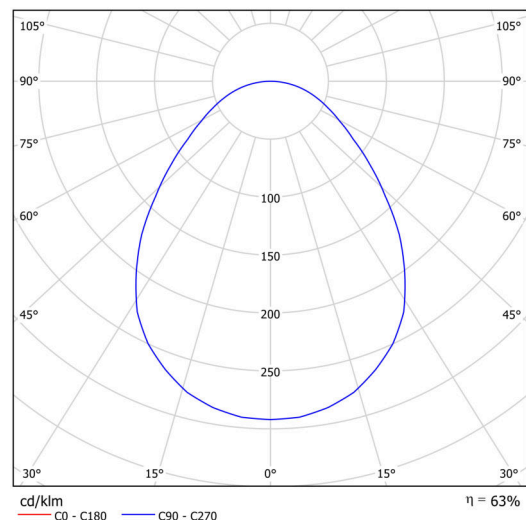

Eulum data for calculation programs are available at www.osmont.cz.

TECHNICAL SHEET



Multipower

Possibility of output adjustment by the user (DIP switch on the current source).

I [mA]	700	600	500	400	
[%]	100	86	71	57	

Logistic

EAN	8591728085117
Warranty*	60 months

*The warranty for the batteries is valid for 12 months from the date of purchase.

Installation dimensions:

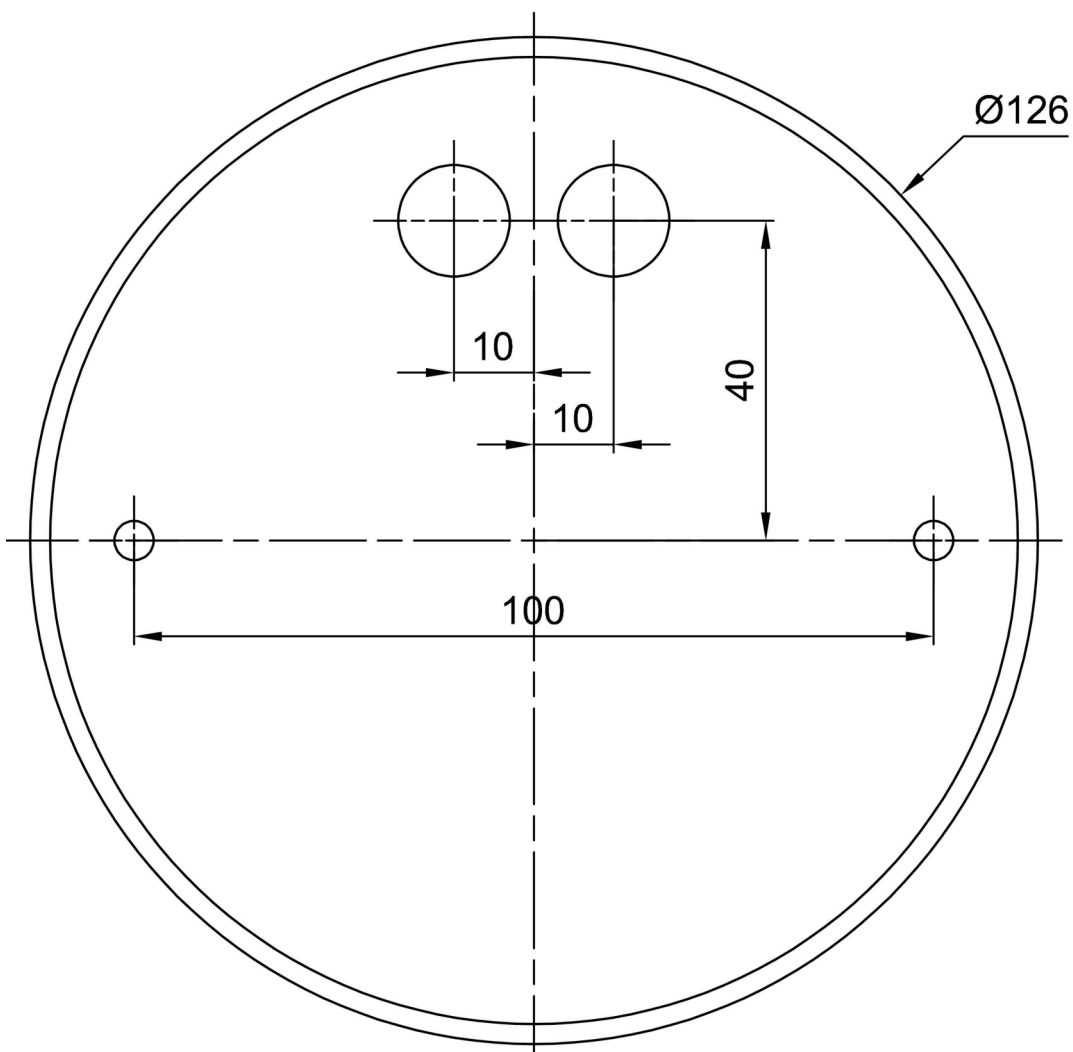

Additional assortment:

Lampshade

Product code	Name	Color	Description	Picture	Drawing
20644	FOP3B	white		