

## KRUGER P2 FC

LED-1L16E700ZKN83/FC2C/z5 C DALI 4K#

[WWW.OSMONT.CZ](http://WWW.OSMONT.CZ)

# KRUGER P2 FC

Product code: KRU60703

Type: LED-1L16E700ZKN83/FC2C/z5 C DALI 4K#

Short description of the luminaire: Black color | pendant LED light | dimmable DALI | design black shade | decorative collar



## Technical

Types of luminaires	Dimmable
Mounting type	Suspended - rod
Base material	steel
Shade material	Black plastic with metal collar
Base color	black Ral9005
Shade color	black
Holding the shade	folding system
Mounting location	ceiling
Width	395 mm
Length	395 mm
Height	80 mm
Diameter	ø 395 mm
Hinge length	1000 mm
mounting holes (diameter)	2xø5mm
Installation wire (diameter)	2xø16mm
Energy Class	D
Operating temperature	from -20°C to +30°C

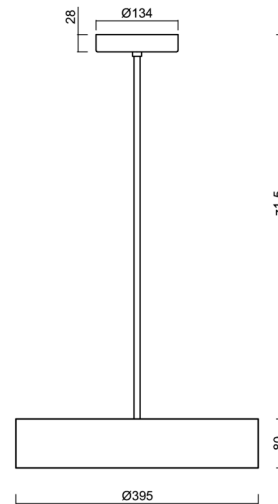
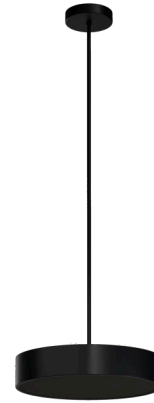

## Electric

Power consumption	34 W
Ingress Protection	IP40
Socket	LED modul
terminal block	screw terminal block
Automatic circuit breaker type B10A	18 pcs
Automatic circuit breaker type B16A	28 pcs
Automatic circuit breaker type C10A	30 pcs
Automatic circuit breaker type C16A	46 pcs

## Luminous

Lum. flux of luminaire	580 lm
Lum. flux of light source	5270 lm
Luminaire efficacy	17 lm/W
Temperature	4000 K
Rated life time LED L80/B10	100000 hours
CRI	Ra80
MacAdam	3
Blue light hazard	Risk group 0

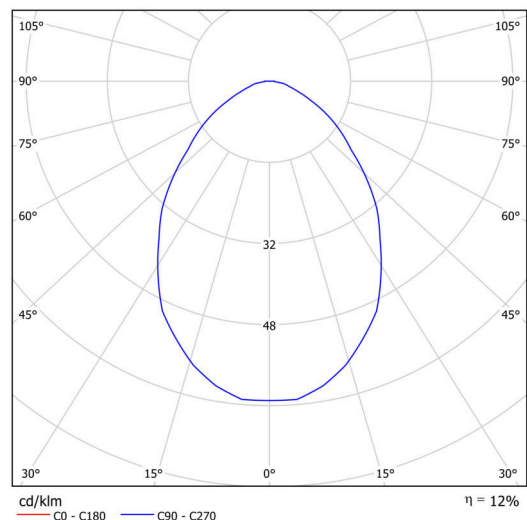

Eulum data for calculation programs are available at [www.osmont.cz](http://www.osmont.cz).

# TECHNICAL SHEET



## Logistic

EAN	8591728085049
Warranty*	60 months

\*The warranty for the batteries is valid for 12 months from the date of purchase.

## Installation dimensions:

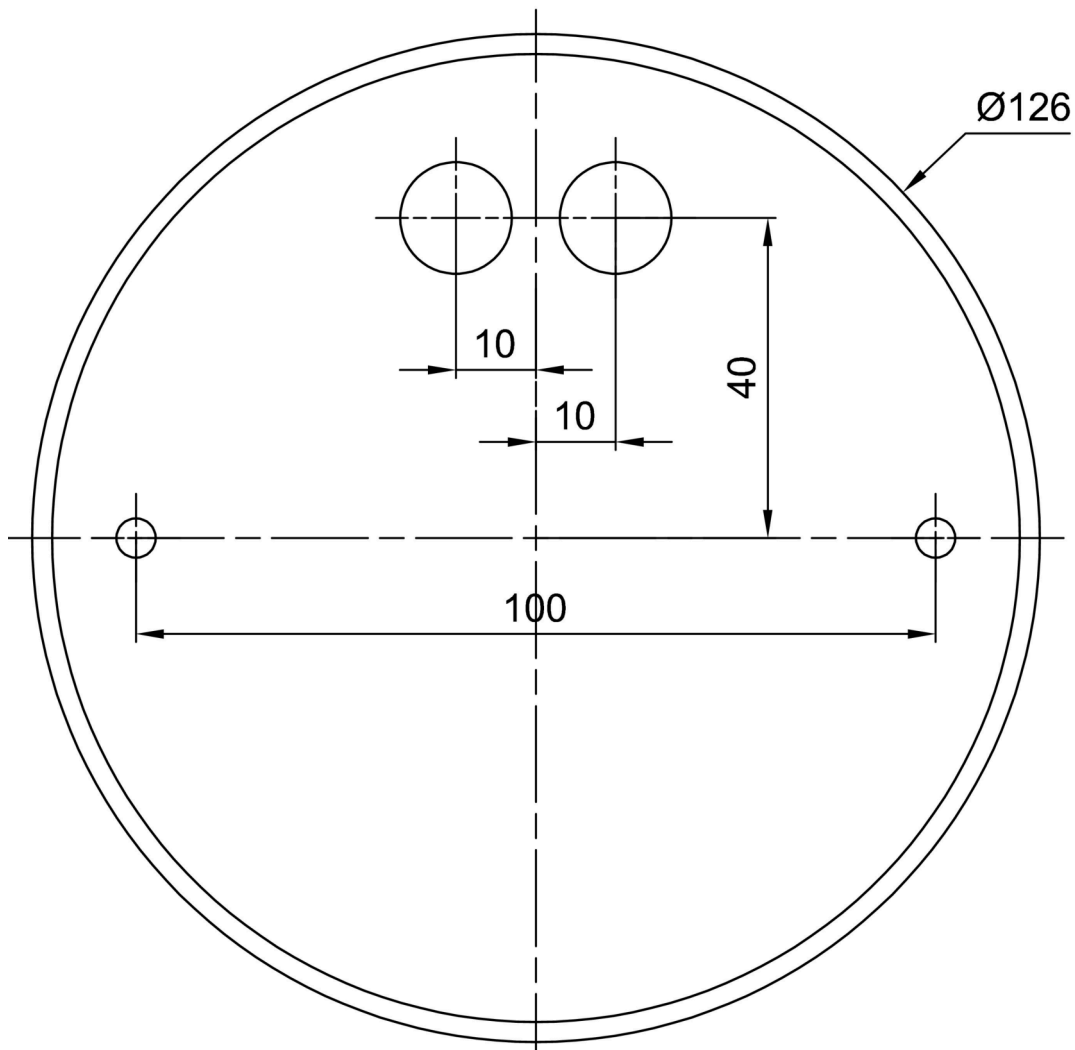

## Additional assortment:

## Lampshade

Product code	Name	Color	Description	Picture	Drawing
20642	FC2C	black		