

KRUGER P1 FOP

LED-1L14E500ZKN62/FOP1C/z5 C DALI 4K#

WWW.OSMONT.CZ

KRUGER P1 FOP

Product code: KRU60669

Type: LED-1L14E500ZKN62/FOP1C/z5 C DALI 4K#

Short description of the luminaire: Black color | pendant LED light | dimmable DALI | opal prismatic shade | decorative collar



Technical

Types of luminaires	Dimmable
Mounting type	Suspended - rod
Base material	steel
Shade material	Plastic opal prismatic (FOP) with metal collar
Base color	black Ral9005
Shade color	white - black
Holding the shade	folding system
Mounting location	ceiling
Width	300 mm
Length	300 mm
Height	80 mm
Diameter	ø 300 mm
Hinge length	1000 mm
mounting holes (diameter)	3xø5mm
Installation wire (diameter)	2xø16mm
Energy Class	D
Operating temperature	from -20°C to +30°C

Electric

Power consumption	18 W
Ingress Protection	IP40
Socket	LED modul
terminal block	snap terminal block
Automatic circuit breaker type B10A	31 pcs
Automatic circuit breaker type B16A	50 pcs
Automatic circuit breaker type C10A	52 pcs
Automatic circuit breaker type C16A	85 pcs

Luminous

Lum. flux of luminaire	1120 lm
Lum. flux of light source	2080 lm
Luminaire efficacy	62 lm/W
Temperature	4000 K
Rated life time LED L80/B10	100000 hours
CRI	Ra80
MacAdam	3
Blue light hazard	Risk group 0

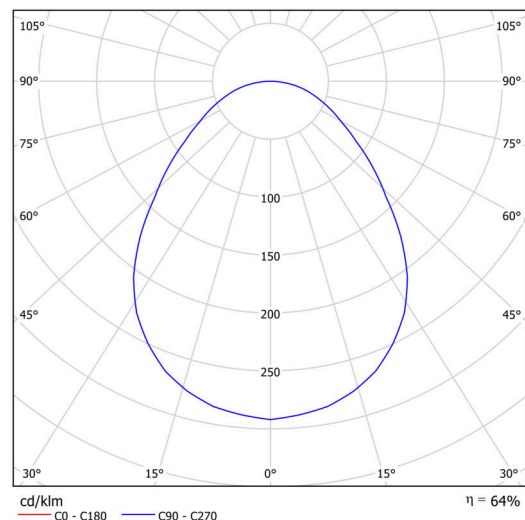
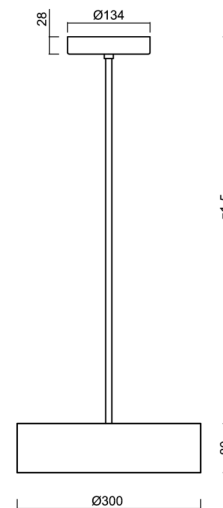

Eulum data for calculation programs are available at www.osmont.cz.

Logistic

EAN	8591728084707
Weight NTT0	2.8 Kg
Weight BTTO	3.6 Kg
Warranty*	60 months

*The warranty for the batteries is valid for 12 months from the date of purchase.

Installation dimensions:

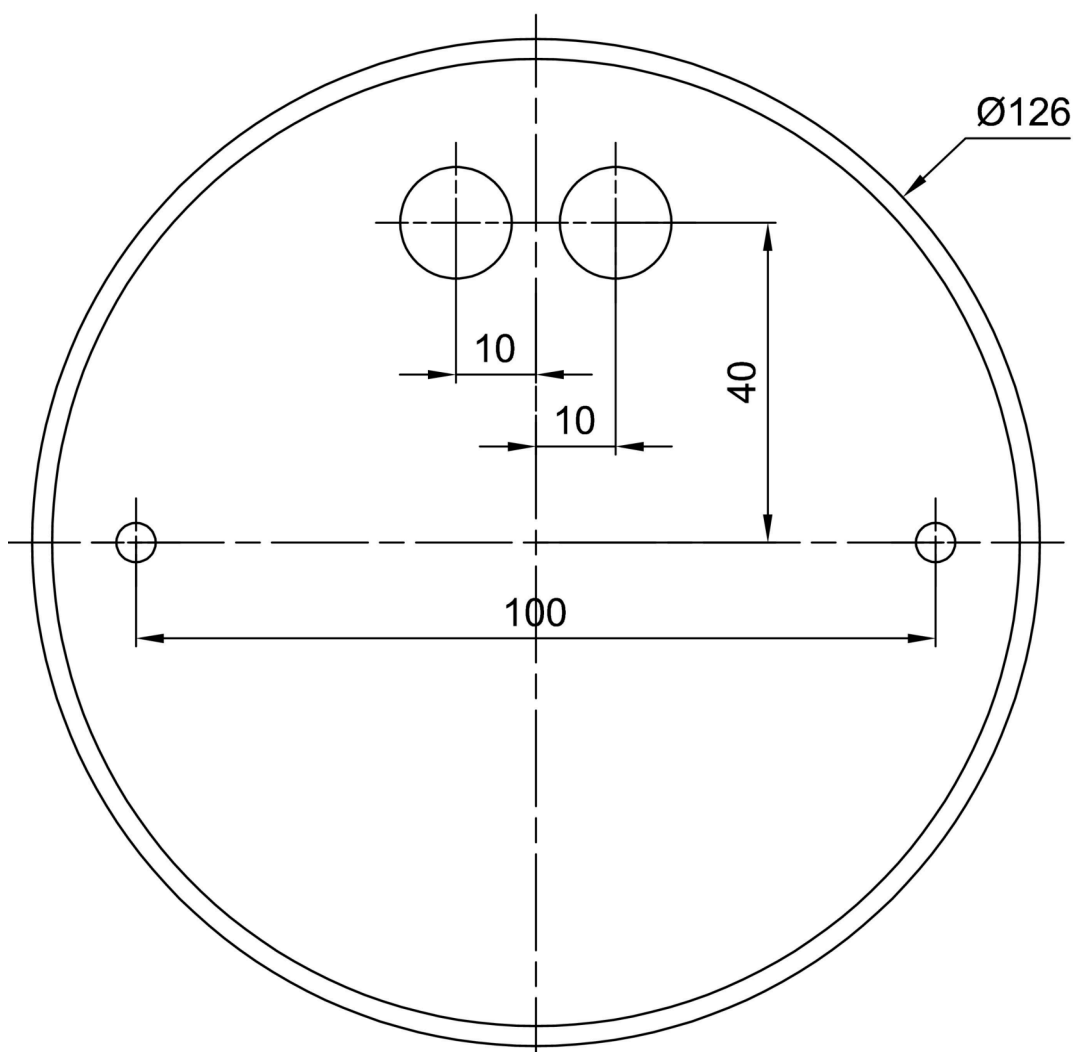

Additional assortment:

Lampshade

Product code	Name	Color	Description	Picture	Drawing
20635	FOP1C	white - black		