



KRUGER 3 FO

LED-1L20EMP700KN94/F03B/NK1W 4K#

WWW.OSMONT.CZ

KRUGER 3 FO

Product code: KRU60608

Type: LED-1L20EMP700KN94/F03B/NK1W 4K#

Short description of the luminaire: White color | surface-mounted LED light | emergency combi unit | multipower function | opal plastic shade | decorative collar

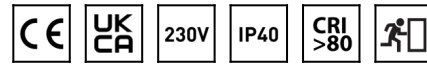

Technical

| | |
|------------------------------|-------------------------------------|
| Types of luminaires | Emergency combined |
| Mounting type | surface mounted |
| Base material | steel |
| Shade material | Plastic opal (FO) with metal collar |
| Base color | white Ral9003 |
| Shade color | white |
| Holding the shade | folding system |
| Mounting location | ceiling/wall |
| Width | 490 mm |
| Length | 490 mm |
| Height | 80 mm |
| Diameter | ø 490 mm |
| mounting holes (diameter) | 3xø5mm |
| Installation wire (diameter) | 2xø16mm |
| Energy Class | D |
| Operating temperature | from 0°C to +30°C |

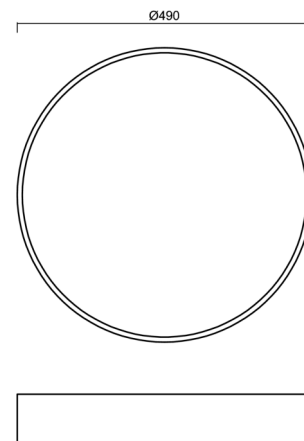

Electric

| | |
|-------------------------------------|---------------------|
| Power consumption | 32 W |
| Ingress Protection | IP40 |
| Socket | LED modul |
| Battery type | NiCd |
| Emergency time | 3 hours |
| terminal block | snap terminal block |
| Automatic circuit breaker type B10A | 26 pcs |
| Automatic circuit breaker type B16A | 40 pcs |
| Automatic circuit breaker type C10A | 30 pcs |
| Automatic circuit breaker type C16A | 48 pcs |

Luminous

| | |
|-----------------------------|--------------|
| Lum. flux of luminaire | 3950 lm |
| Lum. flux of light source | 5560 lm |
| Luminaire efficacy | 123 lm/W |
| Temperature | 4000 K |
| Rated life time LED L80/B10 | 100000 hours |
| CRI | Ra80 |
| MacAdam | 3 |
| Blue light hazard | Risk group 0 |

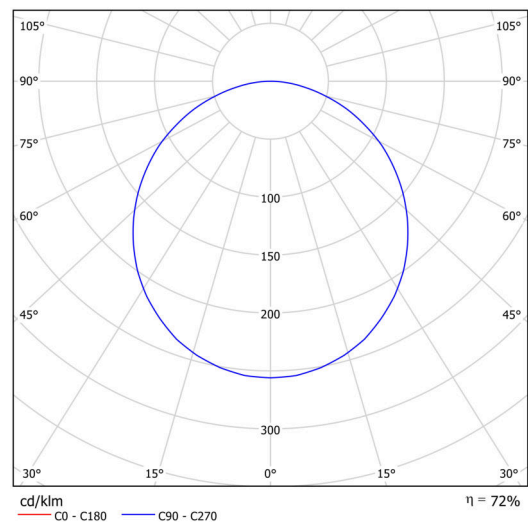

Eulum data for calculation programs are available at

Multipower

Possibility of output adjustment by the user (DIP switch on the current source).

| | | | | | |
|--------|-----|-----|-----|-----|--|
| I [mA] | 700 | 600 | 500 | 400 | |
| [%] | 100 | 86 | 71 | 57 | |

Logistic

| | |
|-------------|---------------|
| EAN | 8591728084097 |
| Weight NTTO | 3.76 Kg |
| Weight BTTO | 4.16 Kg |
| Warranty* | 60 months |

*The warranty for the batteries is valid for 12 months from the date of purchase.

Installation dimensions:

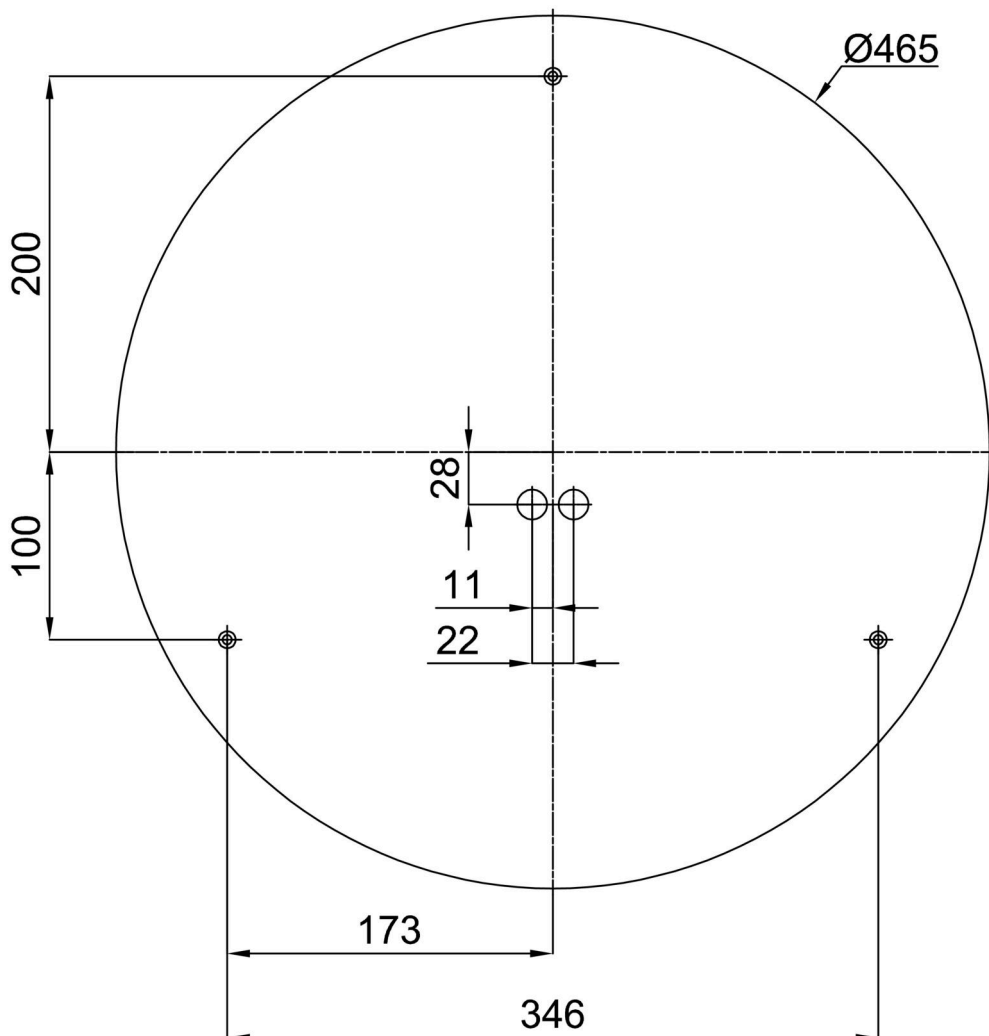

Additional assortment:

Base for surface mounting

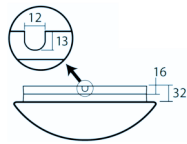
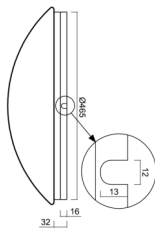
| Product code | Name | Color | Description | Picture | Drawing |
|--------------|----------------|------------------|-------------|--|---|
| 33503 | KN9,K9,B17 /BP | white Ra19003 | |  |  |

Lampshade

| Product code | Name | Color | Description | Picture | Drawing |
|--------------|------|-------|-------------|--|---------|
| 20643 | F03B | white | |  | |