



KRUGER 2 F0

LED-1L16E500KN83/F02C/NK1W 4K#

WWW.OSMONT.CZ

KRUGER 2 FO

Product code: KRU60582

Type: LED-1L16E500KN83/F02C/NK1W 4K#

Short description of the luminaire: Black color | surface-mounted LED light | emergency combi unit | opal plastic shade | decorative collar

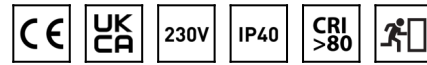

Technical

Types of luminaires	Emergency combined
Mounting type	surface mounted
Base material	steel
Shade material	Plastic opal (FO) with metal collar
Base color	black Ral9005
Shade color	white - black
Holding the shade	folding system
Mounting location	ceiling/wall
Width	395 mm
Length	395 mm
Height	80 mm
Diameter	ø 395 mm
mounting holes (diameter)	3xø5mm
Installation wire (diameter)	2xø16mm
Energy Class	D
Operating temperature	from 0°C to +30°C

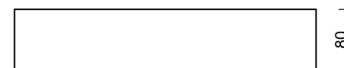
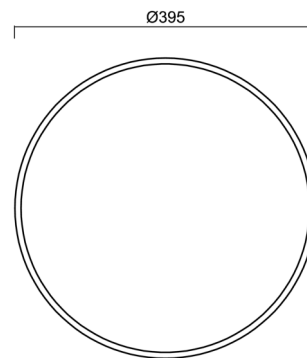

Electric

Power consumption	24 W
Ingress Protection	IP40
Socket	LED modul
Battery type	NiCd
Emergency time	3 hours
terminal block	snap terminal block
Automatic circuit breaker type B10A	26 pcs
Automatic circuit breaker type B16A	40 pcs
Automatic circuit breaker type C10A	30 pcs
Automatic circuit breaker type C16A	48 pcs

Luminous

Lum. flux of luminaire	2500 lm
Lum. flux of light source	3910 lm
Luminaire efficacy	104 lm/W
Temperature	4000 K
Rated life time LED L80/B10	100000 hours
CRI	Ra80
MacAdam	3
Blue light hazard	Risk group 0

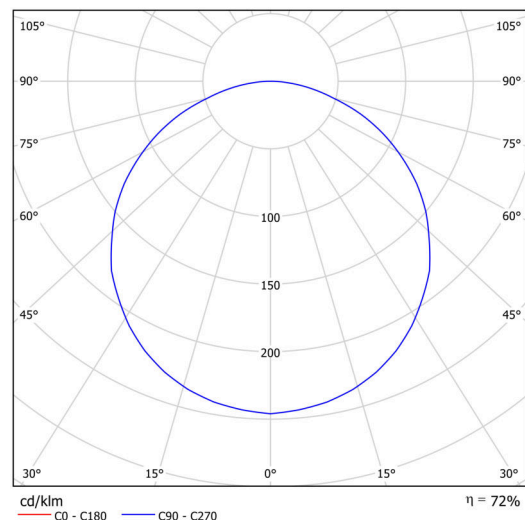

Eulum data for calculation programs are available at

Logistic

EAN	8591728083830
Weight NTT0	2.7 Kg
Weight BTTO	3.1 Kg
Warranty*	60 months

*The warranty for the batteries is valid for 12 months from the date of purchase.

Installation dimensions:

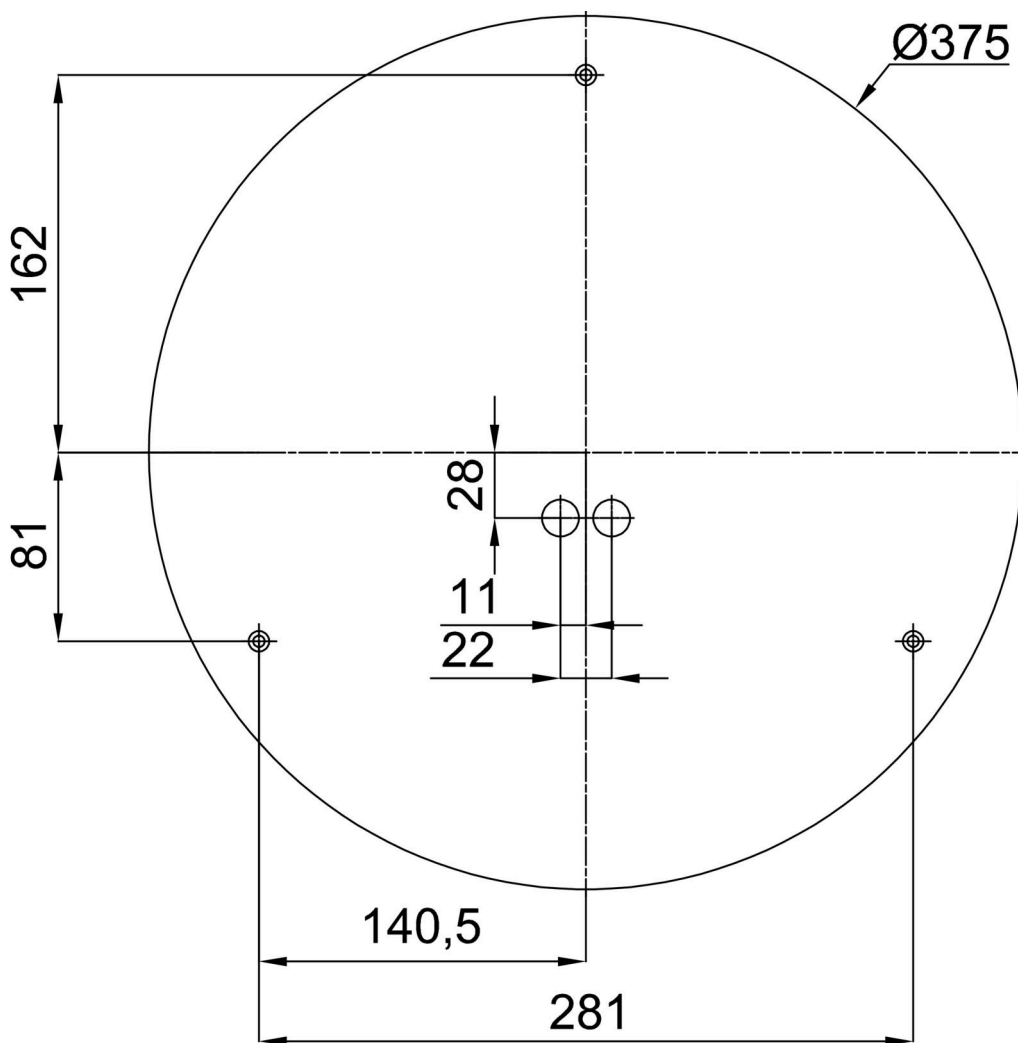

Additional assortment:

Base for surface mounting

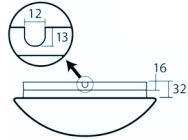
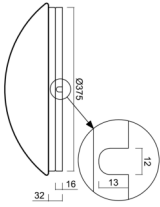
Product code	Name	Color	Description	Picture	Drawing
33502	KN8,K8/BP	white Ra19003			

Lampshade

Product code	Name	Color	Description	Picture	Drawing
20640	F02C	white - black		