



KRUGER 2 F0

LED-1L16E500KN83/F02B HF CORR 3K#

WWW.OSMONT.CZ

KRUGER 2 FO

Product code: KRU60055

Type: LED-1L16E500KN83/F02B HF CORR 3K#

Short description of the luminaire: White color | surface-mounted LED light | CORRIDOR function (HF+DALI) | opal plastic shade | decorative collar

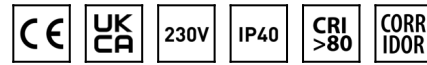

Technical

Types of luminaires	Corridor
Mounting type	surface mounted
Base material	steel
Shade material	Plastic opal (FO) with metal collar
Base color	white Ral9003
Shade color	white
Holding the shade	folding system
Mounting location	ceiling/wall
Width	395 mm
Length	395 mm
Height	80 mm
Diameter	ø 395 mm
mounting holes (diameter)	3xø5mm
Installation wire (diameter)	2xø16mm
Energy Class	D
Operating temperature	from -20°C to +30°C

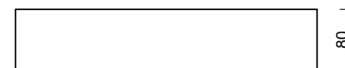
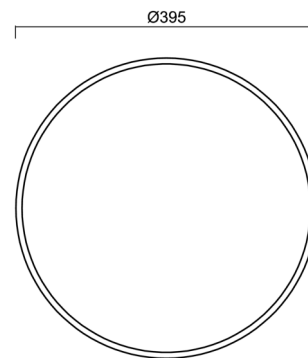

Electric

Power consumption	24 W
Ingress Protection	IP40
Socket	LED modul
Sensor	HF
terminal block	snap terminal block
Automatic circuit breaker type B10A	18 pcs
Automatic circuit breaker type B16A	28 pcs
Automatic circuit breaker type C10A	30 pcs
Automatic circuit breaker type C16A	46 pcs

Luminous

Lum. flux of luminaire	2660 lm
Lum. flux of light source	3750 lm
Luminaire efficacy	110 lm/W
Temperature	3000 K
Rated life time LED L80/B10	100000 hours
CRI	Ra80
MacAdam	3
Blue light hazard	Risk group 0

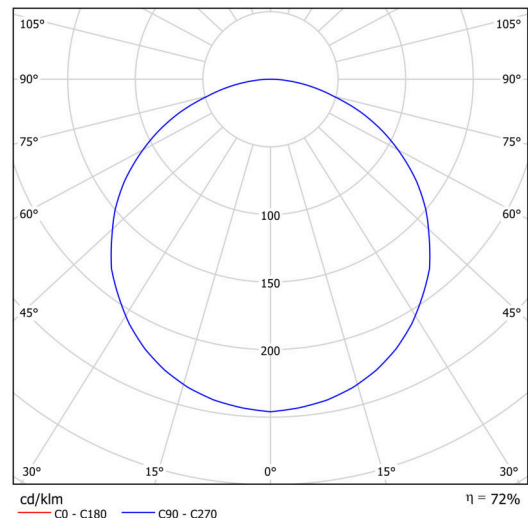

Eulum data for calculation programs are available at www.osmont.cz.

Logistic

EAN	8591728081249
Weight NTTO	2.7 Kg
Weight BTTO	3.1 Kg
Warranty*	60 months

*The warranty for the batteries is valid for 12 months from the date of purchase.

Installation dimensions:

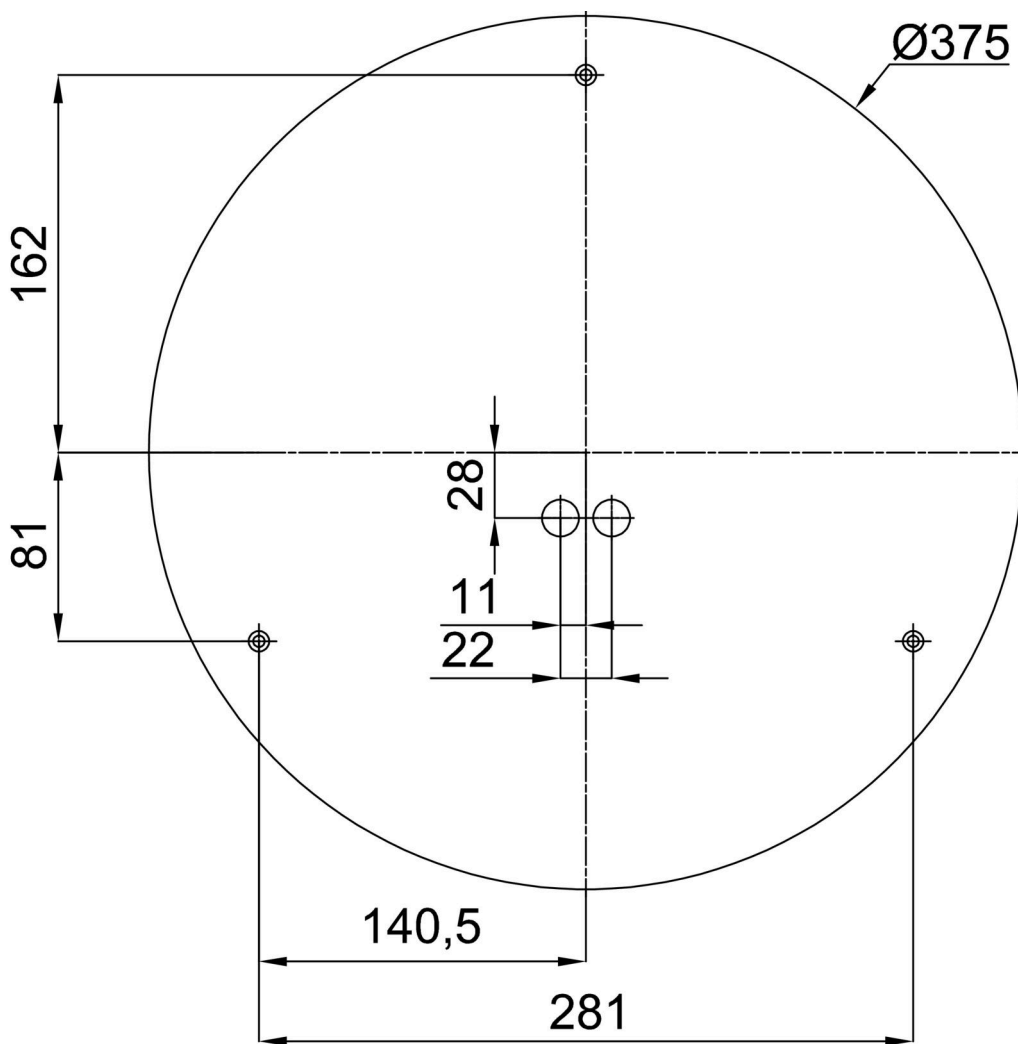

Additional assortment:

Base for surface mounting

Product code	Name	Color	Description	Picture	Drawing
33502	KN8,K8/BP	white Ra19003			

Lampshade

Product code	Name	Color	Description	Picture	Drawing
20637	F02B	white		