



ISIS P4 PM-M HP

LED-5L08E950Z11/PM4M/a5 NK3HST NL 4K##

WWW.OSMONT.CZ

ISIS P4 PM-M HP

Product code: ISI61514

Type: LED-5L08E950Z11/PM4M/a5 NK3HST NL 4K##

Short description of the luminaire: Stainless steel polished | pendant high-power LED light with emergency backup combined (with Self-test) | matt PMMA shade | rod pendant 100 cm |

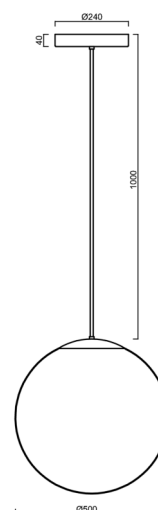

Technical

Types of luminaires	Emergency combined SELFTEST
Mounting type	Suspended - rod
Base material	stainless steel steel
Shade material	opal polymethyl methacrylate
Base color	polished stainless steel
Shade color	white
Holding the shade	steel holder
Mounting location	ceiling
Width	500 mm
Length	500 mm
Height	500 mm
Hinge length	1000 mm
mounting holes (diameter)	3xØ5mm
Cable entrance	2xØ16mm
Energy Class	D
Impact strength	IK06
Operating temperature	from -20°C to +30°C

Electric

Power consumption	59 W
Ingress Protection	IP40
Socket	LED modul
Battery type	LiFePO4
Emergency time	3 hours
SELFTEST	yes
terminal block	snap terminal block

Luminous

Lum. flux of luminaire	8450 lm
Lum. flux of light source	9600 lm
Lum. flux of light source in emergency mode	200 lm
Temperature	4000 K
Rated life time LED L80/B10	100000 hours
CRI	Ra80
MacAdam	3
Blue light hazard	Risk group 0

Eulum data for calculation programs are available at www.osmont.cz.



Logistic

EAN	8591728156787
Weight NTTO	4.4 Kg
Weight BTTO	6.3 Kg
Number of cartons	2 pcs
Package volume	0.185 m ³
Package 1 width	0.52 m
Package 1 length	0.52 m
Package 1 height	0.53 m
Warranty*	60 months

*The warranty for the batteries is valid for 12 months from the date of purchase.

Installation dimensions:

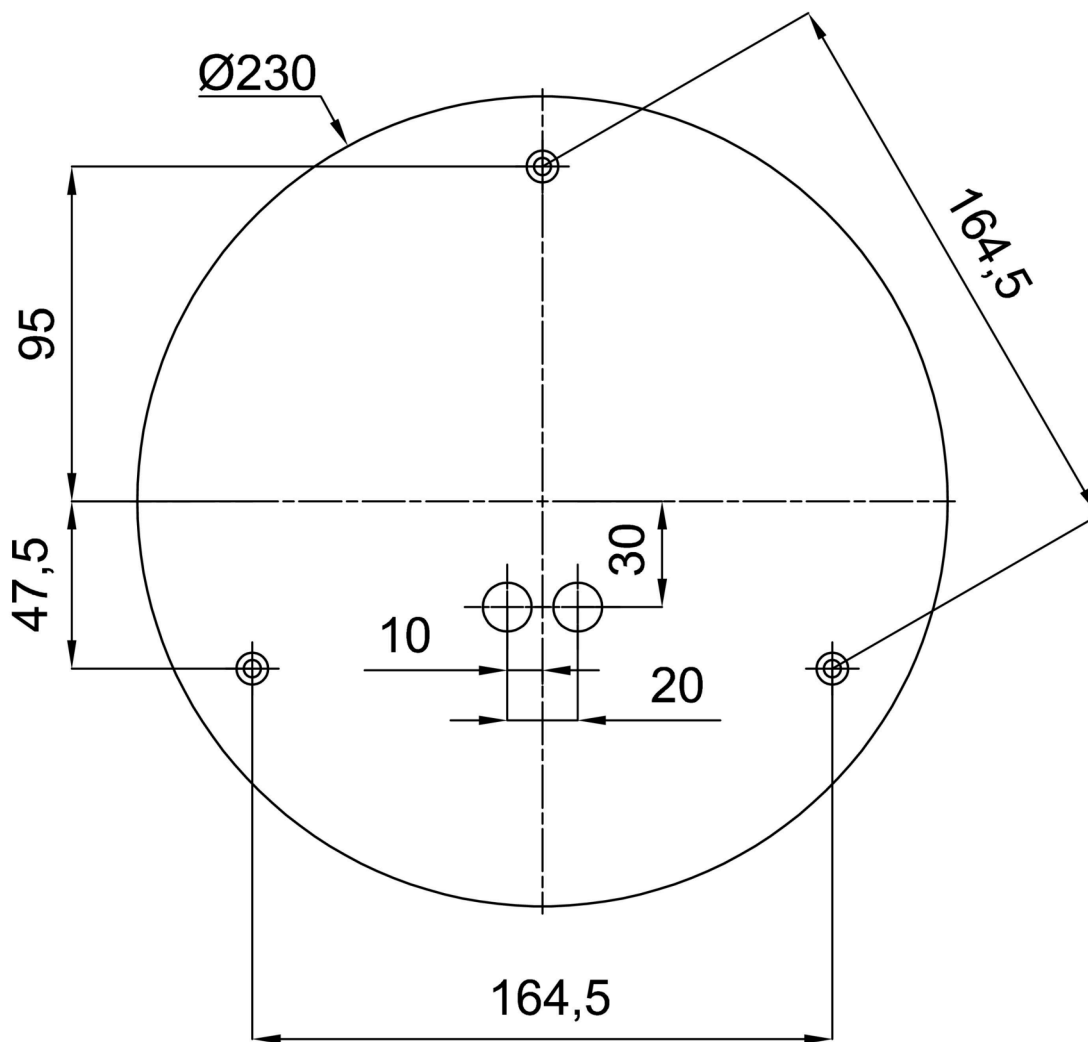

Additional assortment:

Lampshade

Product code	Name	Color	Description	Picture	Drawing
20604	PM4-M	white	příslušenství	