



ISIS P4 PM HP

LED-5L08E950Z11/PM4/a3 MS DALI 4K##

WWW.OSMONT.CZ

ISIS P4 PM HP

Product code: ISI64652

Type: LED-5L08E950Z11/PM4/a3 MS DALI 4K##

Short description of the luminaire: Brass polished | pendant high-power LED light DALI | PMMA shadel rod pendant 60 cm |



Technical

Types of luminaires	Dimmable
Mounting type	Suspended - rod
Base material	brass
Shade material	glossy polymethyl methacrylate
Base color	polished brass
Shade color	white
Holding the shade	steel holder
Mounting location	ceiling
Width	500 mm
Length	500 mm
Height	500 mm
Diameter	ø 500 mm
Hinge length	600 mm
mounting holes (diameter)	3xø5mm
Cable entrance	2xø16mm
Energy Class	D
Impact strength	IK06
Operating temperature	from -20°C to +30°C

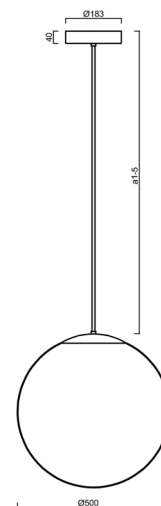

Electric

Power consumption	59 W
Ingress Protection	IP40
Socket	LED modul
terminal block	snap terminal block
Automatic circuit breaker type B10A	15 pcs
Automatic circuit breaker type B16A	25 pcs
Automatic circuit breaker type C10A	26 pcs
Automatic circuit breaker type C16A	42 pcs

Luminous

Lum. flux of luminaire	8450 lm
Lum. flux of light source	9600 lm
Luminaire efficacy	143 lm/W
Temperature	4000 K
Rated life time LED L80/B10	100000 hours
CRI	Ra80
MacAdam	3
Blue light hazard	Risk group 0



Eulum data for calculation programs are available at www.osmont.cz.

Logistic

EAN	8591728031527
Weight NTTO	4.4 Kg
Weight BTTO	6.3 Kg
Number of cartons	2 pcs
Package volume	0.171 m ³
Package 1 width	0.52 m
Package 1 length	0.52 m
Package 1 height	0.53 m
Warranty*	60 months

*The warranty for the batteries is valid for 12 months from the date of purchase.

Installation dimensions:

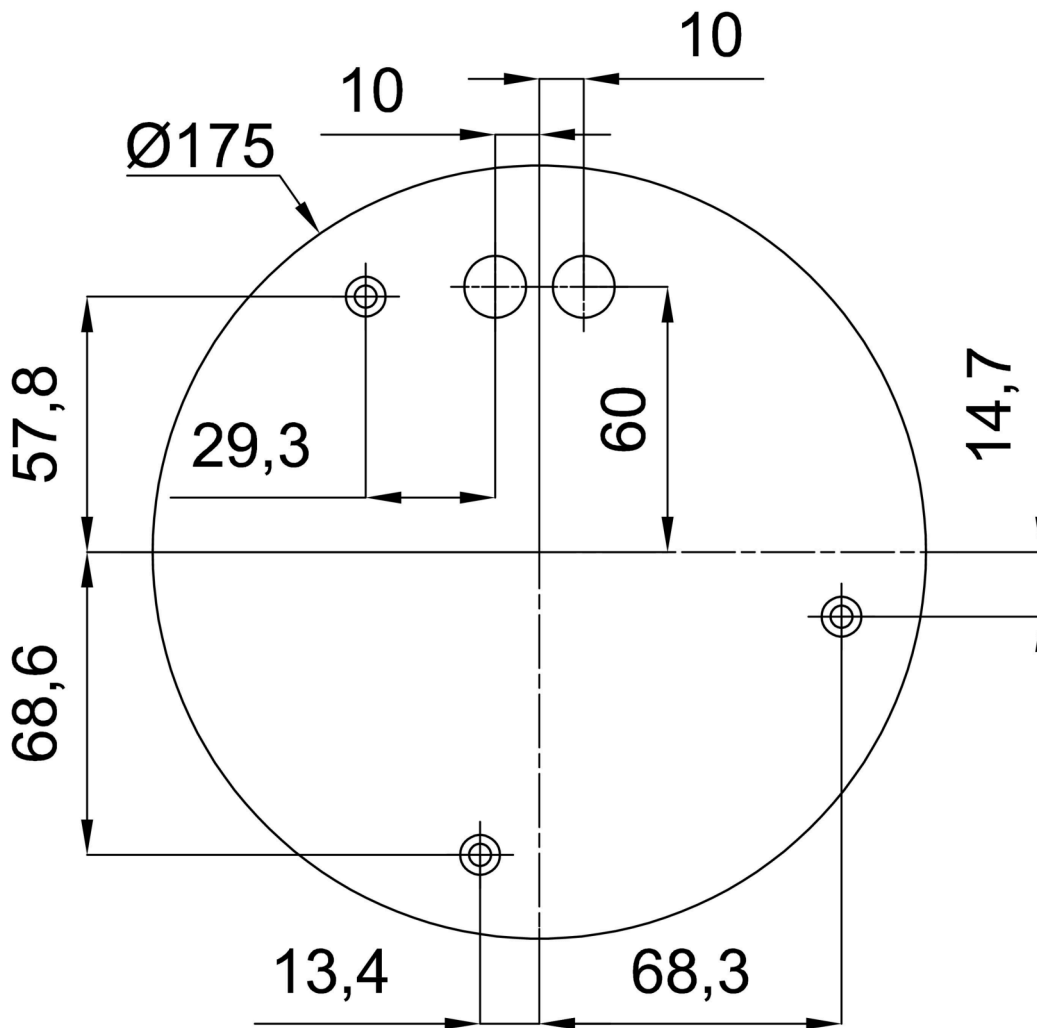

Additional assortment:

Lampshade

Product code	Name	Color	Description	Picture	Drawing
20603	PM4	white	příslušenství		