



ISIS P3A PM HP

LED-5L06E900Z11/PM3A/L80 C 4K#

WWW.OSMONT.CZ

ISIS P3A PM HP

Product code: ISI74623

Type: LED-5L06E900Z11/PM3A/L80 C 4K#

Short description of the luminaire: Black colour | pendant high-power LED light ON/OFF | PMMA shade | rod pendant 80 cm |

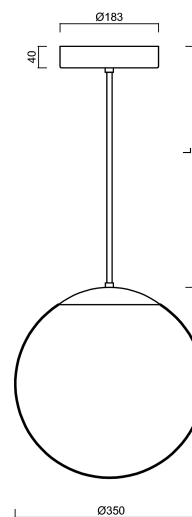

Technical data

Types of luminaires	Classic on/off
Mounting type	Suspended - rod
Base material	steel
Shade material	opal polymethyl methacrylate
Base color	black Ral9005
Shade color	white
Holding the shade	steel holder
Mounting location	ceiling
Width	350 mm
Length	350 mm
Height	350 mm
Diameter	Ø 350 mm
Suspension length	800 mm
mounting holes (diameter)	none
Energy Class	D
Impact strength	IK06
Operating temperature	from -20°C to +30°C

Electrical data

Power consumption	43 W
Ingress Protection	IP40
Socket	LED modul
terminal block	none
Automatic circuit breaker type B10A	10 pcs
Automatic circuit breaker type B16A	16 pcs
Automatic circuit breaker type C10A	16 pcs
Automatic circuit breaker type C16A	26 pcs
Number of LED drivers	1

Luminous data

Lum. flux of luminaire	5870 lm
Lum. flux of light source	6670 lm
Luminaire efficacy	136 lm/W
Chromaticity temperature	4000 K
Rated life time LED L80/B10	100000 hours
CRI	Ra80
MacAdam	3
Blue light hazard	Risk group 0



Eulum data for calculation programs are available at www.osmont.cz.

TECHNICAL SHEET



Logistical data

EAN	8591728219796
Warranty*	60 months

*The warranty for the batteries is valid for 36 months from the date of purchase.

Installation dimensions:

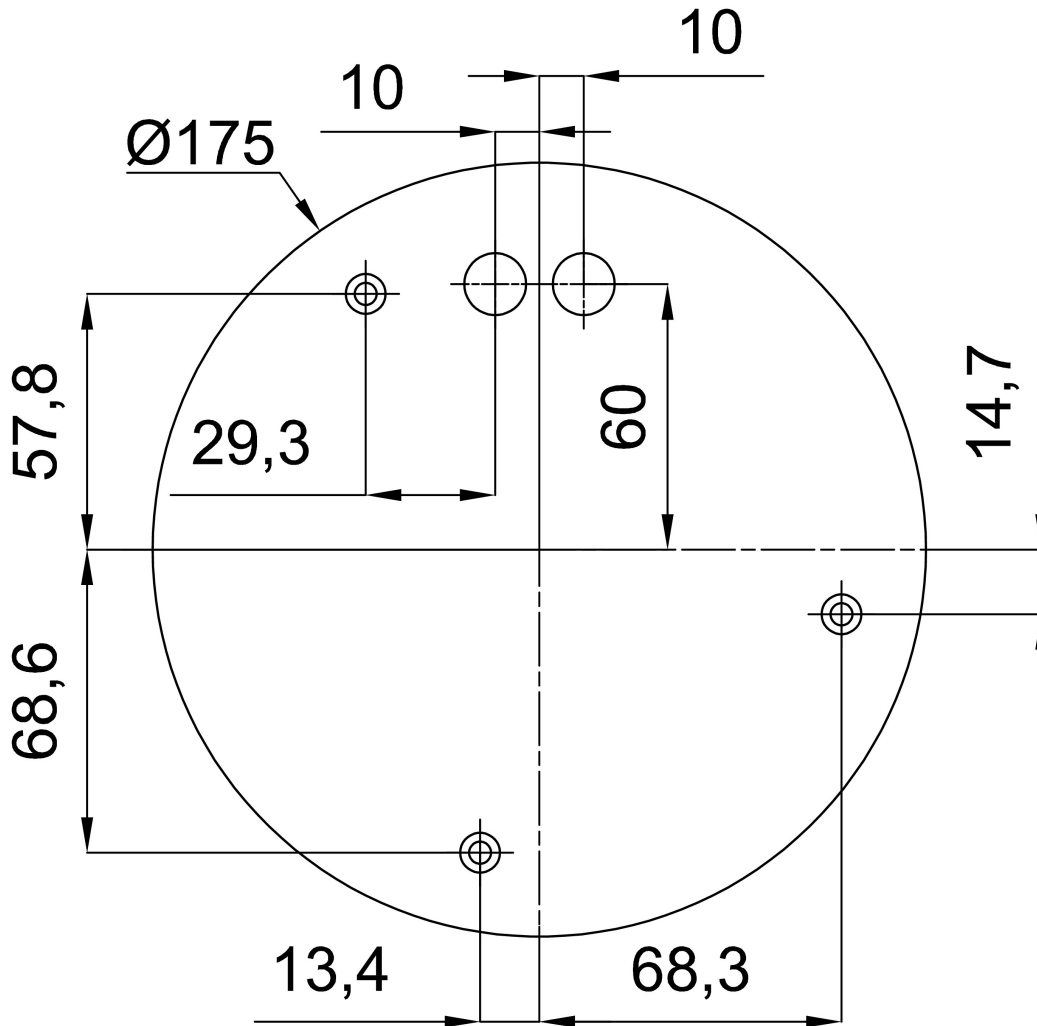

Additional assortment:

Lampshade

Product code	Name	Color	Picture	Drawing
20726	PM3A (400mm)	white		