



ISIS P3 PM HP

LED-5L08E850Z11/PM3/a4/NK1W NB 3K#

WWW.OSMONT.CZ

ISIS P3 PM HP

Product code: ISI72138

Type: LED-5L08E850Z11/PM3/a4/NK1W NB 3K#

Short description of the luminaire: Stainless steel brushed | pendant high-power LED light with emergency backup combined | PMMA shade | rod pendant 80 cm |

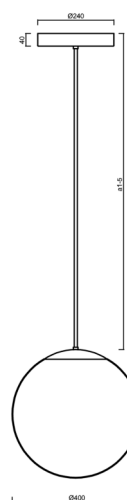

Technical

Types of luminaires	Emergency combined
Mounting type	Suspended - rod
Base material	stainless steel steel
Shade material	glossy polymethyl methacrylate
Base color	brushed stainless steel
Shade color	white
Holding the shade	steel holder
Mounting location	ceiling
Width	400 mm
Length	400 mm
Height	400 mm
Diameter	ø 400 mm
Hinge length	800 mm
mounting holes (diameter)	3xø5mm
Cable entrance	2xø16mm
Energy Class	D
Impact strength	IK06
Operating temperature	from 0°C to +30°C

Electric

Power consumption	52 W
Ingress Protection	IP40
Socket	LED modul
Battery type	NiCd
Emergency time	3 hours
SELFTEST	no
terminal block	snap terminal block
Automatic circuit breaker type B10A	12 pcs
Automatic circuit breaker type B16A	20 pcs
Automatic circuit breaker type C10A	22 pcs
Automatic circuit breaker type C16A	36 pcs

Luminous

Lum. flux of luminaire	7300 lm
Lum. flux of light source	8290 lm
Lum. flux of light source in emergency mode	170 lm
Luminaire efficacy	140 lm/W
Temperature	3000 K
Rated life time LED L80/B10	100000 hours
CRI	Ra80

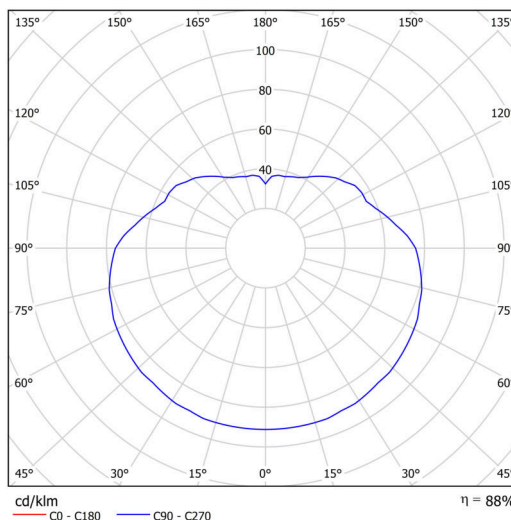

TECHNICAL SHEET



MacAdam	3
Blue light hazard	Risk group 0

Eulum data for calculation programs are available at www.osmont.cz.

Logistic

EAN	8591728044954
Weight NTTO	3.2 Kg
Weight BTTO	4.3 Kg
Number of cartons	2 pcs
Package volume	0.102 m ³
Package 1 width	0.405 m
Package 1 length	0.405 m
Package 1 height	0.41 m
Warranty*	60 months

*The warranty for the batteries is valid for 12 months from the date of purchase.

Installation dimensions:

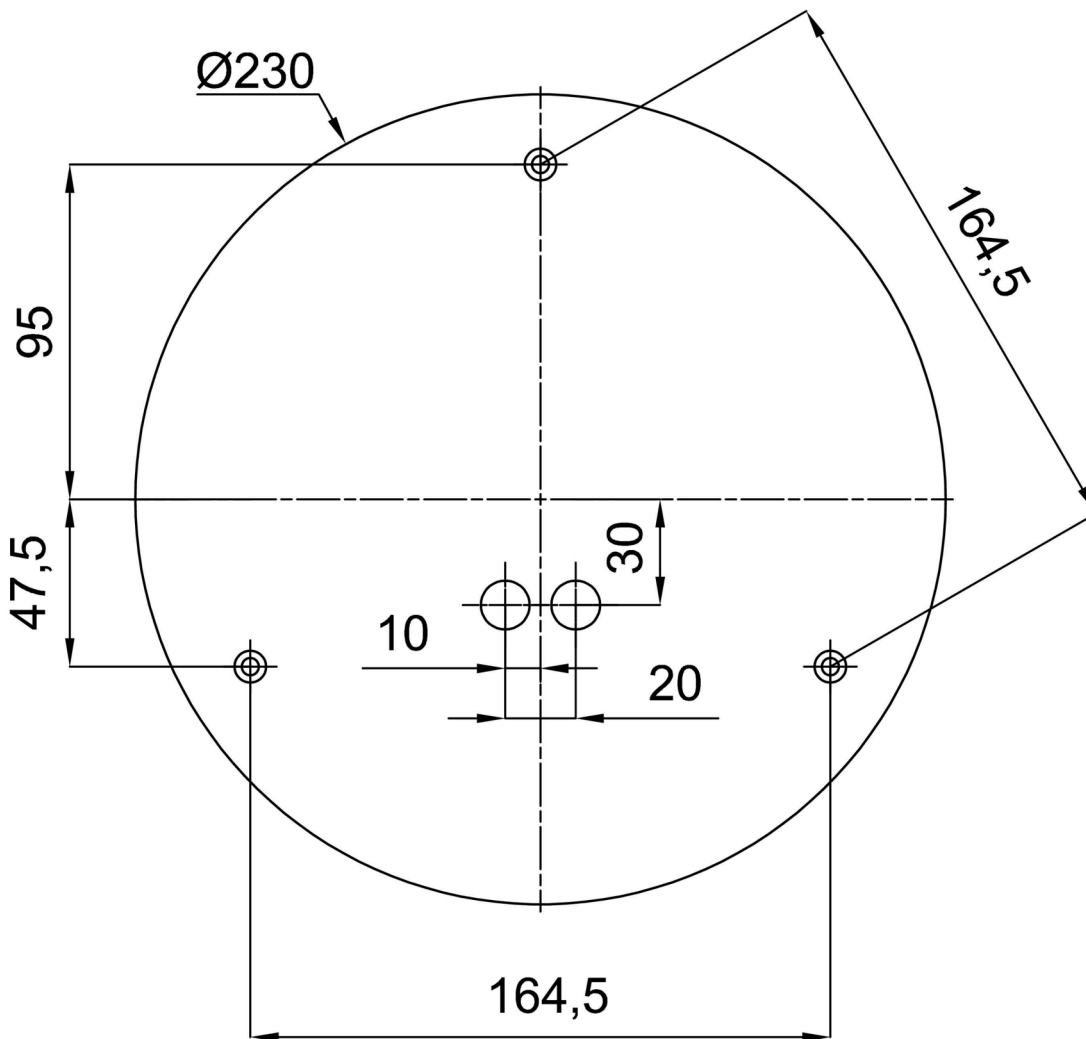

Additional assortment:

Lampshade

Product code	Name	Color	Description	Picture	Drawing
20601	PM3	white	příslušenství		