



ISIS P3 PE HP

LED-5L08E850Z11/PE3/a4 NL 4K#

WWW.OSMONT.CZ

ISIS P3 PE HP

Product code: ISI62933

Type: LED-5L08E850Z11/PE3/a4 NL 4K#

Short description of the luminaire: Stainless steel polished | pendant high-power LED light ON/OFF | polyethylene shadel rod pendant 80 cm |

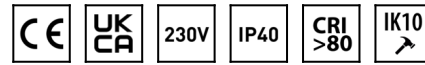

Technical

Types of luminaires	Classic on/off
Mounting type	Suspended - rod
Base material	stainless steel steel
Shade material	polyethylene
Base color	polished stainless steel
Shade color	white
Holding the shade	folding system
Mounting location	ceiling
Width	400 mm
Length	400 mm
Height	400 mm
Diameter	ø 400 mm
Hinge length	800 mm
mounting holes (diameter)	3xø5mm
Cable entrance	2xø16mm
Energy Class	D
Impact strength	IK10
Operating temperature	from -20°C to +30°C

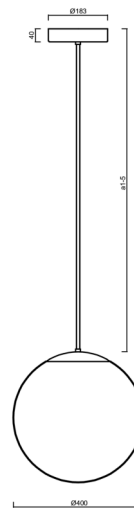

Electric

Power consumption	52 W
Ingress Protection	IP40
Socket	LED modul
terminal block	snap terminal block
Automatic circuit breaker type B10A	15 pcs
Automatic circuit breaker type B16A	25 pcs
Automatic circuit breaker type C10A	26 pcs
Automatic circuit breaker type C16A	42 pcs

Luminous

Lum. flux of luminaire	7610 lm
Lum. flux of light source	8650 lm
Luminaire efficacy	146 lm/W
Temperature	4000 K
Rated life time LED L80/B10	100000 hours
CRI	Ra80
MacAdam	3
Blue light hazard	Risk group 0



Eulum data for calculation programs are available at www.osmont.cz.

Logistic

EAN	8591728019730
Weight NTTO	3.2 Kg
Weight BTTO	4.3 Kg
Number of cartons	2 pcs
Package volume	0.102 m ³
Package 1 width	0.405 m
Package 1 length	0.405 m
Package 1 height	0.41 m
Warranty*	60 months

*The warranty for the batteries is valid for 12 months from the date of purchase.

Installation dimensions:

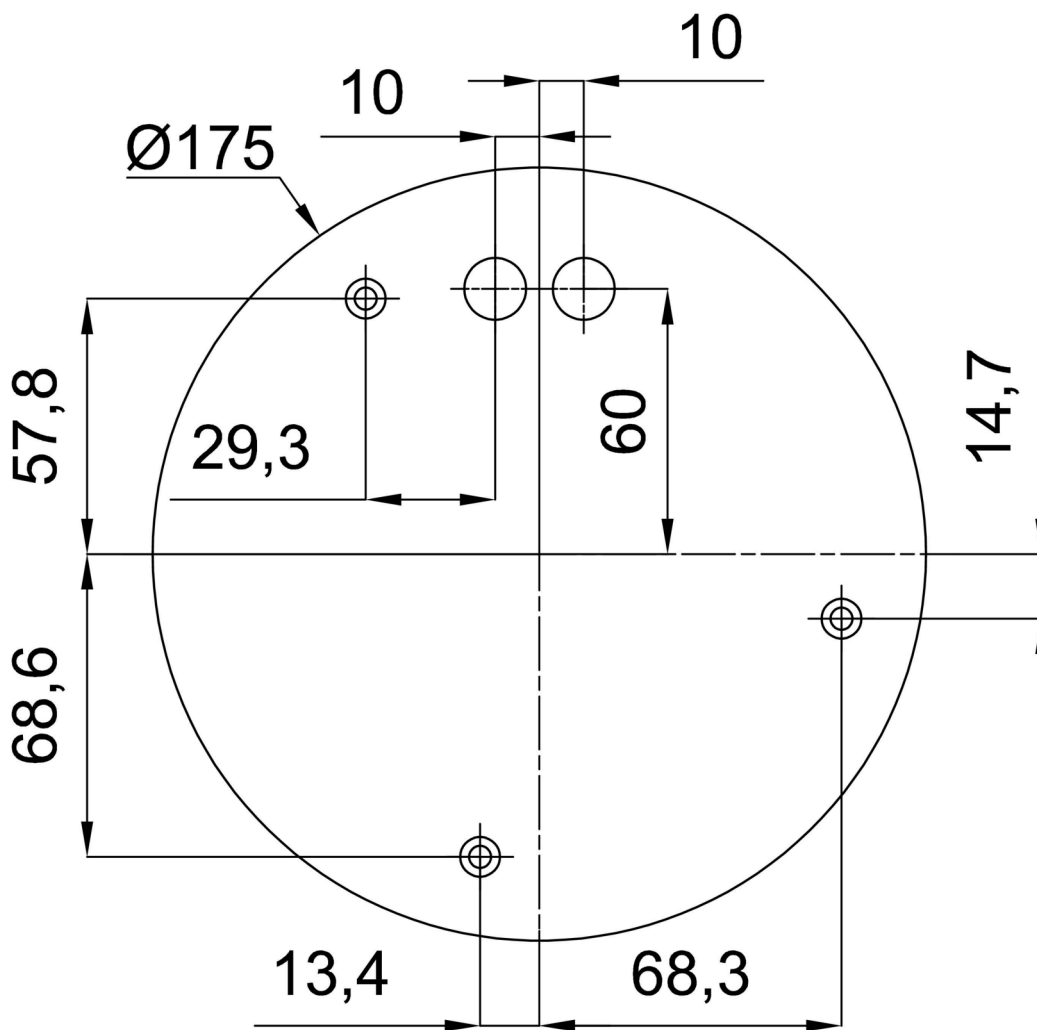

Additional assortment:

Lampshade

Product code	Name	Color	Description	Picture	Drawing
20530	PE3	white	příslušenství		