



ISIS L3A PM-M HP

LED-5L06E900ZL11/PM3AM/L100 NK3HST NL 3K#

WWW.OSMONT.CZ

ISIS L3A PM-M HP

Product code: ISI75035

Type: LED-5L06E900ZL11/PM3AM/L100 NK3HST NL 3K#

Short description of the luminaire: Stainless steel polished | pendant high-power LED light with emergency backup combined (with Self-test) | matt PMMA shade| steel wire pendant (with supply cable) 100 cm |

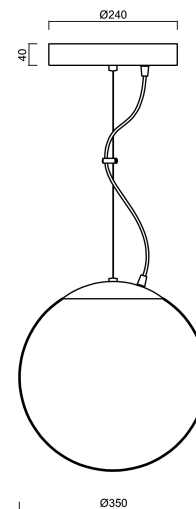
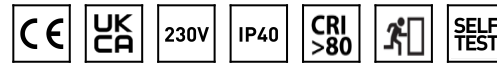

Technical data

Types of luminaires	Emergency combined SELFTEST
Mounting type	Suspended - wire
Base material	stainless steel steel
Shade material	opal polymethyl methacrylate
Base color	polished stainless steel
Shade color	white
Holding the shade	steel holder
Mounting location	ceiling
Width	350 mm
Length	350 mm
Height	350 mm
Diameter	Ø 350 mm
Suspension length	1000 mm
mounting holes (diameter)	none
Energy Class	D
Impact strength	IK06
Operating temperature	from +5°C to +30°C

Electrical data

Power consumption	43 W
Ingress Protection	IP40
Socket	LED modul
Battery type	LiFePO4
Emergency time	3 hours
SELFTEST	yes
terminal block	none
Automatic circuit breaker type B10A	7 pcs
Automatic circuit breaker type B16A	12 pcs
Automatic circuit breaker type C10A	13 pcs
Automatic circuit breaker type C16A	21 pcs
Number of LED drivers	1

Luminous data

Lum. flux of luminaire	5630 lm
Lum. flux of light source	6400 lm
Lum. flux of light source in emergency mode	200 lm
Luminaire efficacy	130 lm/W
Chromaticity temperature	3000 K



TECHNICAL SHEET

Rated life time LED L80/B10	100000 hours
CRI	Ra80
MacAdam	3
Blue light hazard	Risk group 0

Eulum data for calculation programs are available at www.osmont.cz.

Logistical data

EAN	8591728223717
Warranty*	60 months

*The warranty for the batteries is valid for 36 months from the date of purchase.

Installation dimensions:

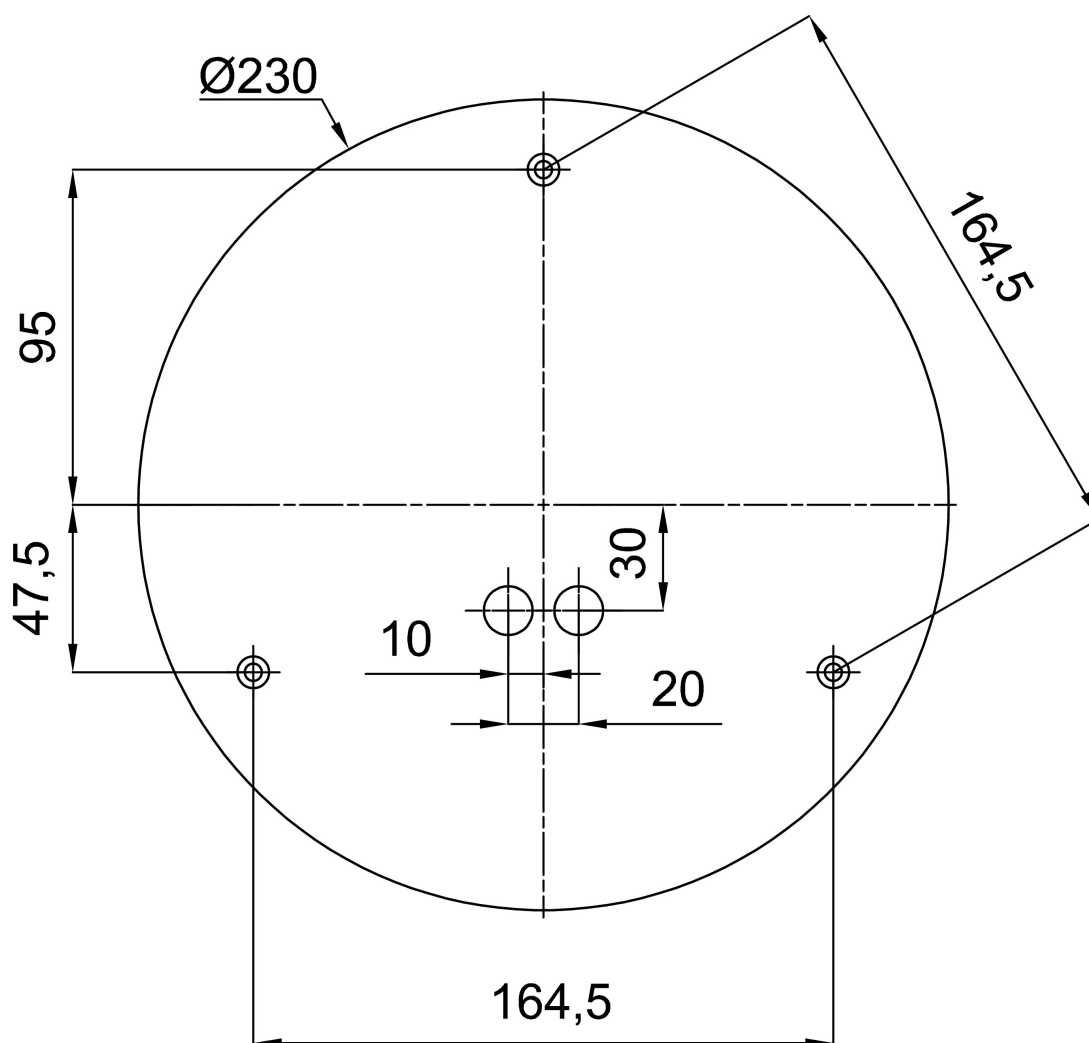

Additional assortment:

Lampshade

Product code	Name	Color	Picture	Drawing
20727	PM3AM (350mm)	white	