



# IRIDA 1

---

LED-1L12E700BD12/PC62 4K#

[WWW.OSMONT.CZ](http://WWW.OSMONT.CZ)

# IRIDA 1

Product code: IRI71568

Type: LED-1L12E700BD12/PC62 4K#

Short description of the luminaire: White surface-mounted LED light ON/OFF and polycarbonate shade



## Technical

Types of luminaires	Classic on/off
Mounting type	surface mounted
Base material	polypropylene composite
Shade material	opal polycarbonate
Base color	white Ra9003
Shade color	white
Holding the shade	bayonet
Mounting location	ceiling/wall
Width	222 mm
Length	222 mm
Height	74 mm
Diameter	Ø 222 mm
mounting holes (diameter)	3xØ5mm
Installation wire (diameter)	2xØ16mm
Energy Class	D
Impact strength	IK10
Operating temperature	from -20°C to +30°C

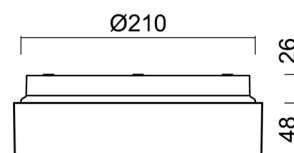
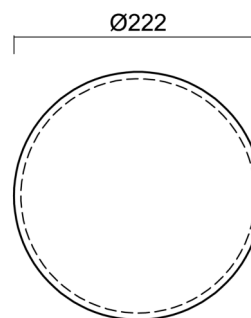

## Electric

Power consumption	10 W
Ingress Protection	IP65
Socket	LED modul
terminal block	snap terminal block
Automatic circuit breaker type B10A	50 pcs
Automatic circuit breaker type B16A	78 pcs
Automatic circuit breaker type C10A	84 pcs
Automatic circuit breaker type C16A	130 pcs

## Luminous

Lum. flux of luminaire	1060 lm
Lum. flux of light source	1410 lm
Luminaire efficacy	106 lm/W
Temperature	4000 K
Rated life time LED L80/B10	100000 hours
CRI	Ra80
MacAdam	3
Blue light hazard	Risk group 0

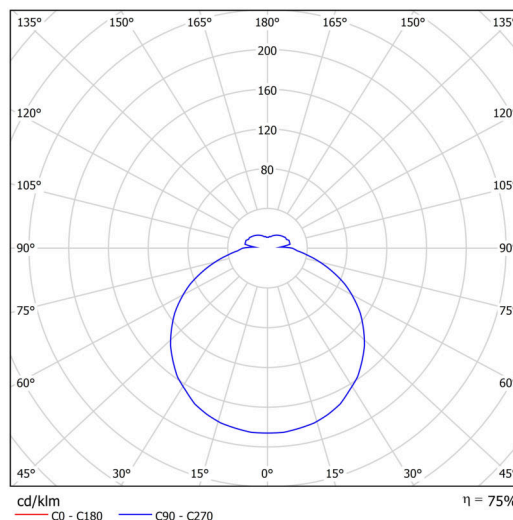

Eulum data for calculation programs are available at [www.osmont.cz](http://www.osmont.cz).

Logistic

EAN	8591728138035
Weight NTTO	0.3 Kg
Weight BTTO	0.5 Kg
Number of cartons	1 pcs
Package volume	0.01 m <sup>3</sup>
Package 1 width	0.28 m
Package 1 length	0.28 m
Package 1 height	0.125 m
Warranty*	60 months

\*The warranty for the batteries is valid for 12 months from the date of purchase.

Installation dimensions:

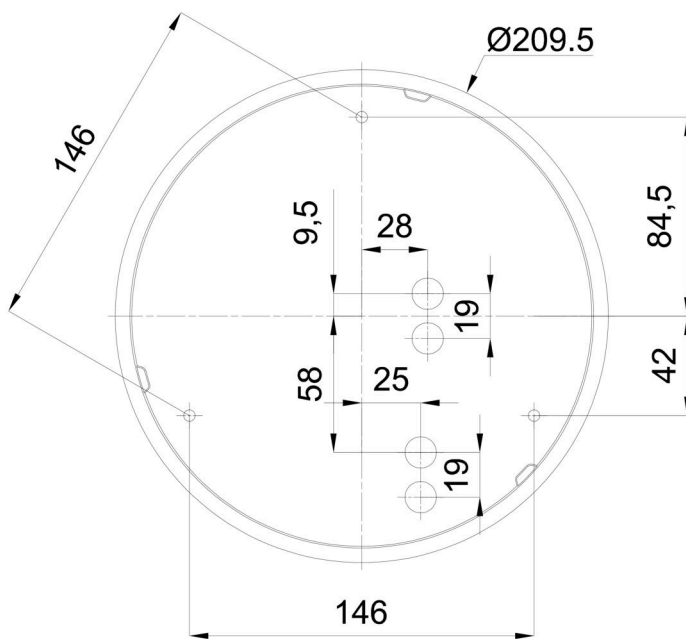

Additional assortment:

Lampshade

Product code	Name	Color	Description	Picture	Drawing
20610	PC62	white		