



ELSA 4

LED-1L16E350BT15/029 3/4K#

WWW.OSMONT.CZ

ELSA 4

Product code: ELS71231

Type: LED-1L16E350BT15/029 3/4K#

Short description of the luminaire: White surface-mounted changeable LED light ON/OFF with TRIPLEX OPAL glass shade



Technical

Types of luminaires	Classic on/off
Mounting type	surface mounted
Base material	steel
Shade material	three-layer glass TRIPLEX OPAL
Base color	white Ral9003
Shade color	white
Holding the shade	bayonet
Mounting location	ceiling/wall
Width	420 mm
Length	420 mm
Height	90 mm
Diameter	ø 420 mm
mounting holes (diameter)	3xø5mm
Installation wire (diameter)	2xø16mm
Energy Class	D
Impact strength	IK01
Operating temperature	from -20°C to +30°C

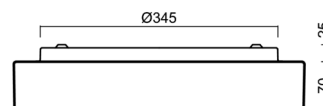
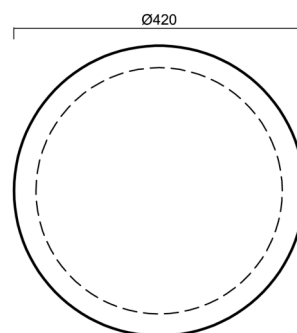

Electric

Power consumption	17 W
Ingress Protection	IP44
Socket	LED modul
terminal block	snap terminal block
Automatic circuit breaker type B10A	65 pcs
Automatic circuit breaker type B16A	105 pcs
Automatic circuit breaker type C10A	39 pcs
Automatic circuit breaker type C16A	63 pcs

Luminous

Lum. flux of luminaire	1780/1860 lm
Lum. flux of light source	2660/2770 lm
Luminaire efficacy	104 lm/W
Temperature	3000/4000 K
Rated life time LED L80/B10	100000 hours
CRI	Ra80
MacAdam	3
Blue light hazard	Risk group 0

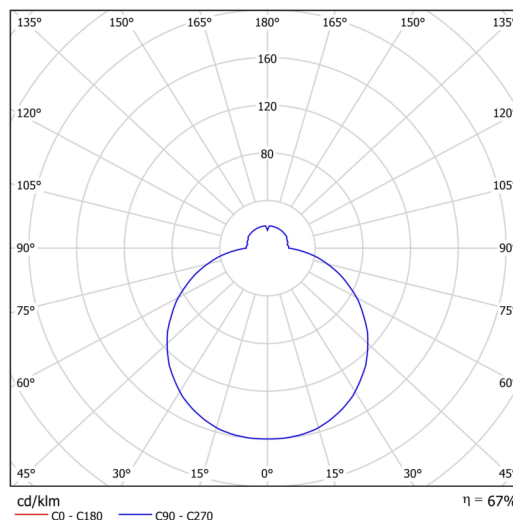

Eulum data for calculation programs are available at www.osmont.cz.

Logistic

EAN	8591728098162
Weight NTTO	3.7 Kg
Weight BTTO	4.1 Kg
Number of cartons	1 pcs
Package volume	0.023 m ³
Package 1 width	0.435 m
Package 1 length	0.435 m
Package 1 height	0.12 m
Warranty*	60 months



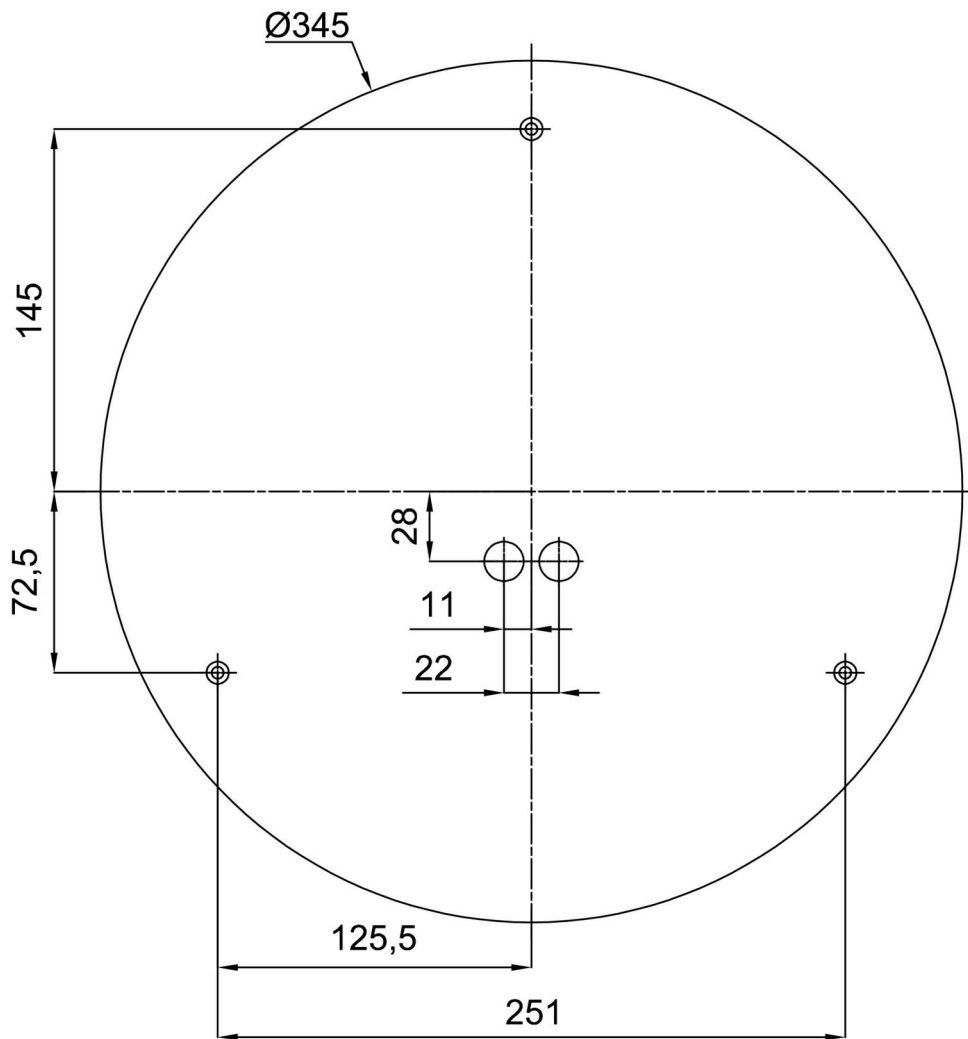

*The warranty for the batteries is valid for 12 months from the date of purchase.

Installation dimensions:



Additional assortment:

Decorative collar

Product code	Name	Color	Description	Picture	Drawing
30140	B15/X14	polished stainless steel	the collar is held by the shade		
30139	B15/X4	white Ral9003	the collar is held by the shade		
30142	B15/X13	grey	the collar is held by the shade		
30141	B15/X12	polished brass	the collar is held by the shade		

Base for surface mounting

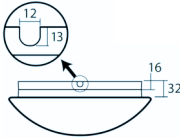
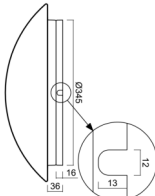
Product code	Name	Color	Description	Picture	Drawing
33506	B15/BP	white Ral9003			

Lampshade

Product code	Name	Color	Description	Picture	Drawing
20083	029	white		