



ELSA 3

LED-1L15E500BT14/027/NK1W HF 3K#

WWW.OSMONT.CZ

ELSA 3

Product code: ELS68071

Type: LED-1L15E500BT14/027/NK1W HF 3K#

Short description of the luminaire: White surface-mounted LED light with emergency unit combined with sensor with TRIPLEX OPAL glass shade.

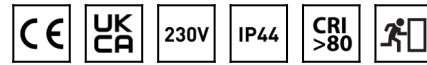

Technical

| | |
|------------------------------|--------------------------------|
| Types of luminaires | Emergency combined + sensor |
| Mounting type | surface mounted |
| Base material | steel |
| Shade material | three-layer glass TRIPLEX OPAL |
| Base color | white Ral9003 |
| Shade color | white |
| Holding the shade | bayonet |
| Mounting location | ceiling/wall |
| Width | 360 mm |
| Length | 360 mm |
| Height | 88 mm |
| Diameter | ø 360 mm |
| mounting holes (diameter) | 3xø5mm |
| Installation wire (diameter) | 2xø16mm |
| Energy Class | D |
| Impact strength | IK01 |
| Operating temperature | from -20°C to +30°C |

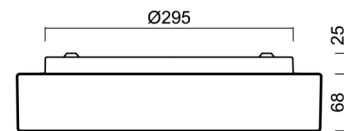
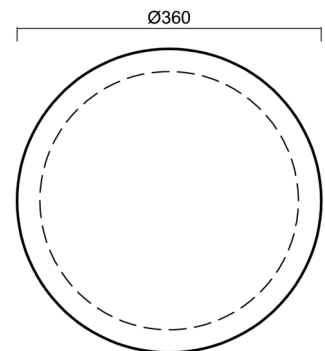

Electric

| | |
|-------------------------------------|---------------------|
| Power consumption | 19 W |
| Ingress Protection | IP44 |
| Socket | LED modul |
| Sensor | HF |
| Battery type | NiCd |
| Emergency time | 3 hours |
| terminal block | snap terminal block |
| Automatic circuit breaker type B10A | 26 pcs |
| Automatic circuit breaker type B16A | 40 pcs |
| Automatic circuit breaker type C10A | 30 pcs |
| Automatic circuit breaker type C16A | 48 pcs |

Luminous

| | |
|---|--------------|
| Lum. flux of luminaire | 2100 lm |
| Lum. flux of light source | 3000 lm |
| Lum. flux of light source in emergency mode | 150 lm |
| Luminaire efficacy | 110 lm/W |
| Temperature | 3000 K |
| Rated life time LED L80/B10 | 100000 hours |
| CRI | Ra80 |

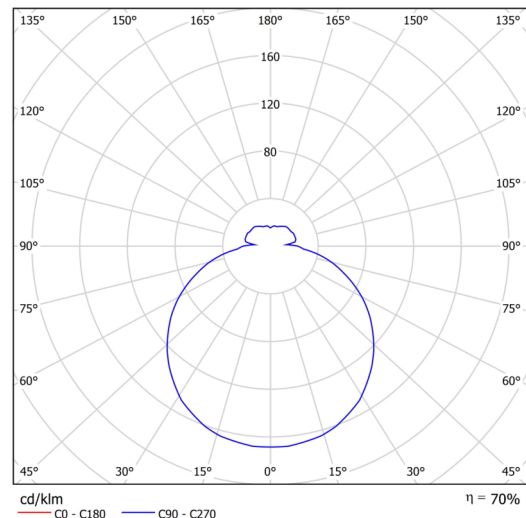

TECHNICAL SHEET



| | |
|-------------------|--------------|
| MacAdam | 3 |
| Blue light hazard | Risk group 0 |

Eulum data for calculation programs are available at www.osmont.cz.

Logistic

| | |
|-------------------|----------------------|
| EAN | 8591728095949 |
| Weight NTTO | 3.1 Kg |
| Weight BTTO | 3.4 Kg |
| Number of cartons | 1 pcs |
| Package volume | 0.016 m ³ |
| Package 1 width | 0.375 m |
| Package 1 length | 0.355 m |
| Package 1 height | 0.12 m |
| Warranty* | 60 months |



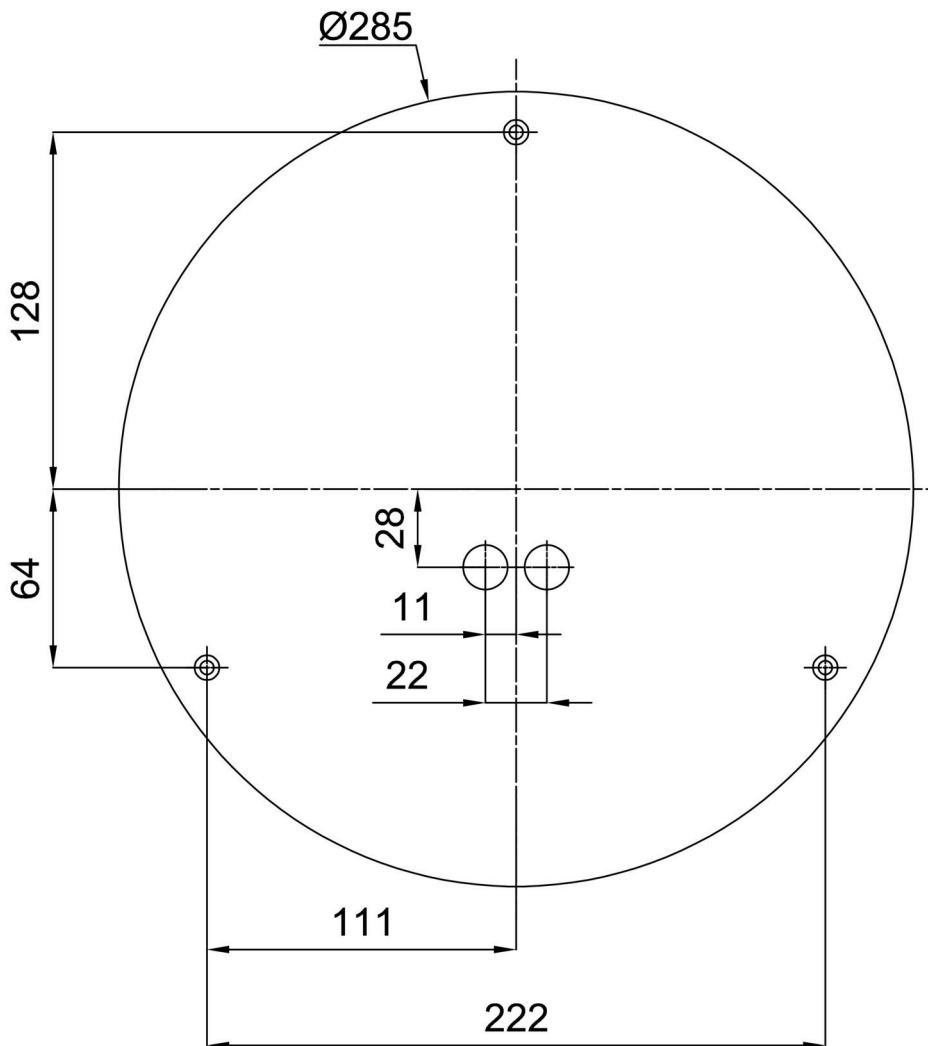

*The warranty for the batteries is valid for 12 months from the date of purchase.

Installation dimensions:



Additional assortment:

Decorative collar

| Product code | Name | Color | Description | Picture | Drawing |
|--------------|---------|--------------------------|---------------------------------|--|---------|
| 30136 | B14/X14 | polished stainless steel | the collar is held by the shade |  | |
| 30135 | B14/X4 | white Ral9003 | the collar is held by the shade |  | |
| 30138 | B14/X13 | grey | the collar is held by the shade |  | |
| 30137 | B14/X12 | polished brass | the collar is held by the shade |  | |

Base for surface mounting

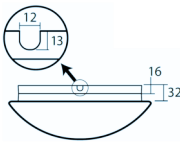
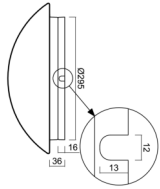
| Product code | Name | Color | Description | Picture | Drawing |
|--------------|--------|---------------|-------------|--|---|
| 33505 | B14/BP | white Ral9003 | |  |  |

Lampshade

| Product code | Name | Color | Description | Picture | Drawing |
|--------------|------|-------|-------------|--|---------|
| 20082 | 027 | white | |  | |