



ELSA 3

LED-1L15E500BT14/027 DALI 3K#

WWW.OSMONT.CZ

ELSA 3

Product code: ELS68068

Type: LED-1L15E500BT14/027 DALI 3K#

Short description of the luminaire: White colour | ceiling or wall LED light DALI | TRIPLEX OPAL hand blown glass shade|

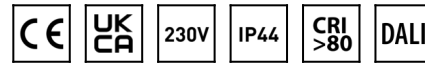

Technical

Types of luminaires	Dimmable
Mounting type	surface mounted
Base material	steel
Shade material	three-layer glass TRIPLEX OPAL
Base color	white Ral9003
Shade color	white
Holding the shade	bayonet
Mounting location	ceiling/wall
Width	360 mm
Length	360 mm
Height	88 mm
Diameter	ø 360 mm
mounting holes (diameter)	3xø5mm
Cable entrance	2xø16mm
Energy Class	D
Impact strength	IK01
Operating temperature	from -20°C to +30°C

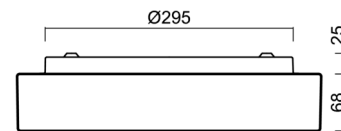
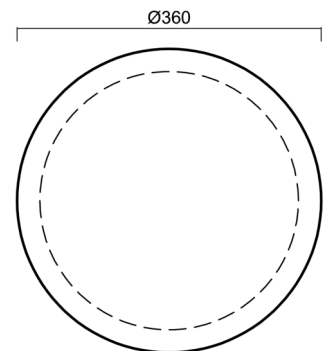

Electric

Power consumption	19 W
Ingress Protection	IP44
Socket	LED modul
terminal block	snap terminal block
Automatic circuit breaker type B10A	31 pcs
Automatic circuit breaker type B16A	50 pcs
Automatic circuit breaker type C10A	52 pcs
Automatic circuit breaker type C16A	85 pcs

Luminous

Lum. flux of luminaire	2100 lm
Lum. flux of light source	3000 lm
Luminaire efficacy	110 lm/W
Temperature	3000 K
Rated life time LED L80/B10	100000 hours
CRI	Ra80
MacAdam	3
Blue light hazard	Risk group 0

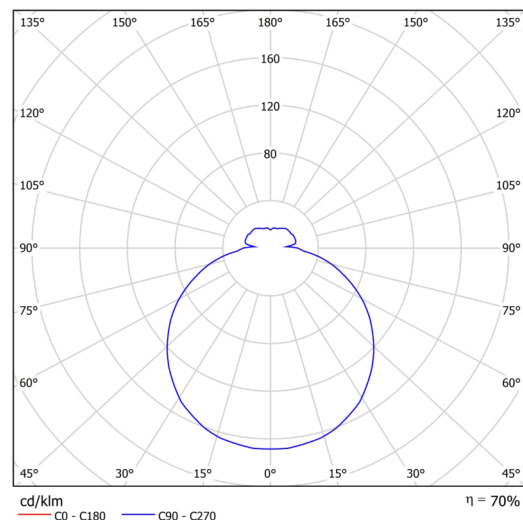

Eulum data for calculation programs are available at www.osmont.cz.

Logistic

EAN	8591728095918
Weight NTTO	3.1 Kg
Weight BTTO	3.4 Kg
Number of cartons	1 pcs
Package volume	0.016 m ³
Package 1 width	0.375 m
Package 1 length	0.355 m
Package 1 height	0.12 m
Warranty*	60 months



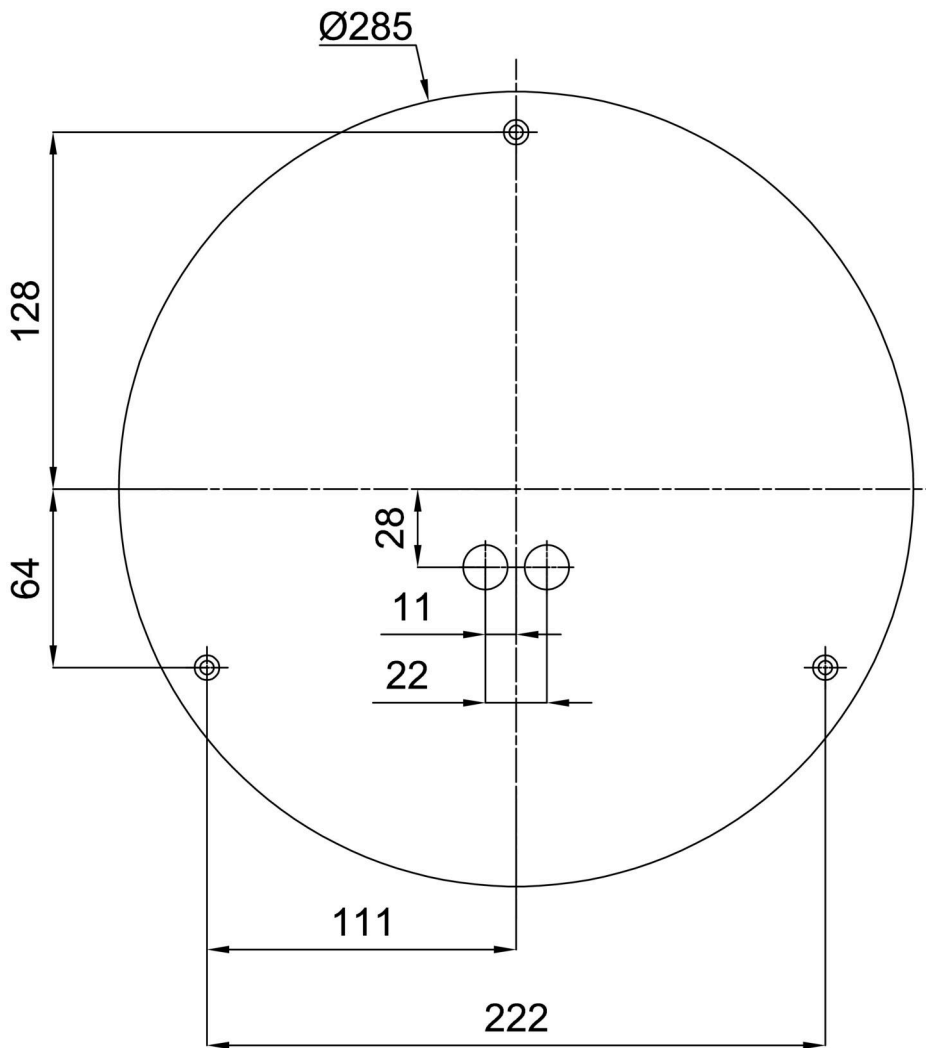

*The warranty for the batteries is valid for 12 months from the date of purchase.

Installation dimensions:



Additional assortment:

Decorative collar

Product code	Name	Color	Description	Picture	Drawing
30136	B14/X14	polished stainless steel	příslušenství		
30135	B14/X4	white Ral9003	příslušenství		
30138	B14/X13	grey	příslušenství		
30137	B14/X12	polished brass	příslušenství		

Base for surface mounting

Product code	Name	Color	Description	Picture	Drawing
33505	B14/BP	white Ral9003	příslušenství		

Lampshade

Product code	Name	Color	Description	Picture	Drawing
20082	027	white	příslušenství	