



ELSA 2

LED-1L14E500BT13/025 DALI 4K#

WWW.OSMONT.CZ

ELSA 2

Product code: ELS59947

Type: LED-1L14E500BT13/025 DALI 4K#

Short description of the luminaire: White surface-mounted LED light DALI with TRIPLEX OPAL glass shade.

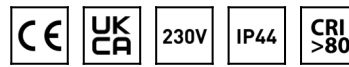

Technical

| | |
|------------------------------|--------------------------------|
| Types of luminaires | Dimmable |
| Mounting type | surface mounted |
| Base material | steel |
| Shade material | three-layer glass TRIPLEX OPAL |
| Base color | white Ral9003 |
| Shade color | white |
| Holding the shade | bayonet |
| Mounting location | ceiling/wall |
| Width | 300 mm |
| Length | 300 mm |
| Height | 86 mm |
| Diameter | ø 300 mm |
| mounting holes (diameter) | 3xø5mm |
| Installation wire (diameter) | 2xø16mm |
| Energy Class | D |
| Impact strength | IK01 |
| Operating temperature | from -20°C to +30°C |

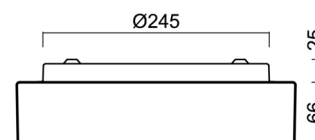
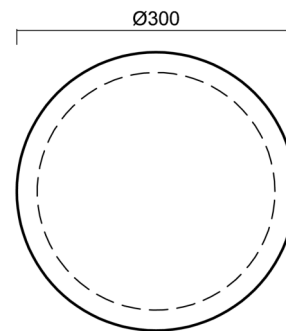

Electric

| | |
|-------------------------------------|---------------------|
| Power consumption | 13 W |
| Ingress Protection | IP44 |
| Socket | LED modul |
| terminal block | snap terminal block |
| Automatic circuit breaker type B10A | 31 pcs |
| Automatic circuit breaker type B16A | 50 pcs |
| Automatic circuit breaker type C10A | 52 pcs |
| Automatic circuit breaker type C16A | 85 pcs |

Luminous

| | |
|-----------------------------|--------------|
| Lum. flux of luminaire | 1520 lm |
| Lum. flux of light source | 2080 lm |
| Luminaire efficacy | 116 lm/W |
| Temperature | 4000 K |
| Rated life time LED L80/B10 | 100000 hours |
| CRI | Ra80 |
| MacAdam | 3 |
| Blue light hazard | Risk group 0 |

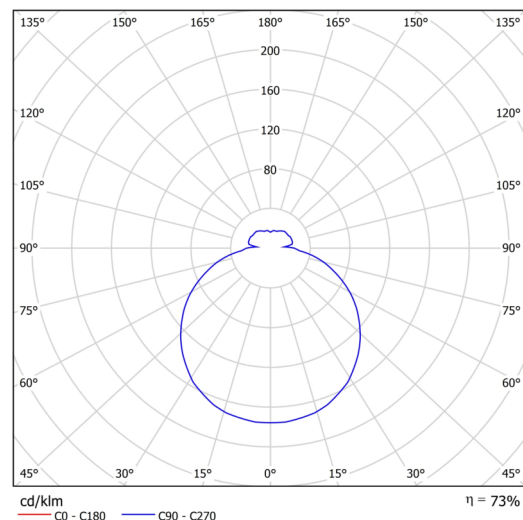

Eulum data for calculation programs are available at www.osmont.cz.

Logistic

| | |
|-------------------|----------------------|
| EAN | 8591728095765 |
| Weight NTTO | 2.1 Kg |
| Weight BTTO | 2.4 Kg |
| Number of cartons | 1 pcs |
| Package volume | 0.012 m ³ |
| Package 1 width | 0.32 m |
| Package 1 length | 0.31 m |
| Package 1 height | 0.12 m |
| Warranty* | 60 months |

*The warranty for the batteries is valid for 12 months from the date of purchase.

Installation dimensions:

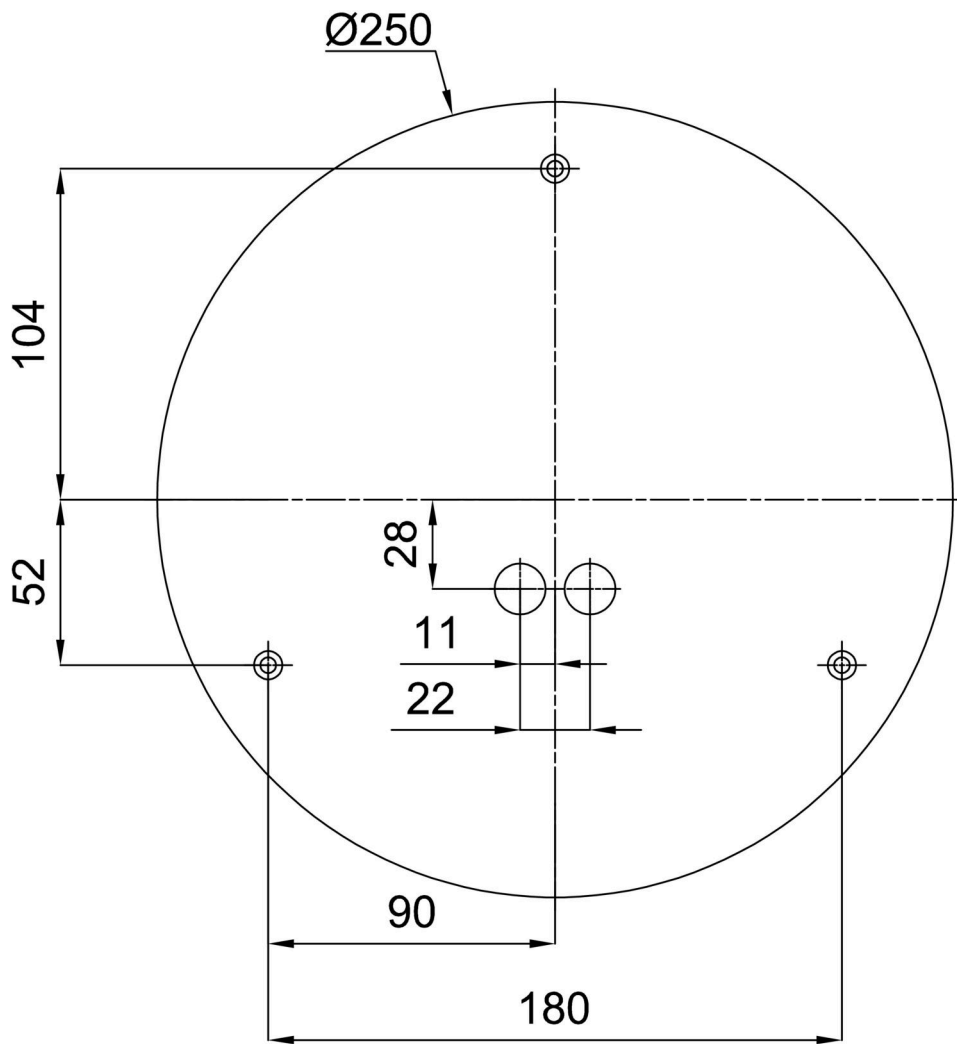

Additional assortment:

Decorative collar

| Product code | Name | Color | Description | Picture | Drawing |
|--------------|---------|--------------------------|---------------------------------|--|---------|
| 30069 | B13/X14 | polished stainless steel | the collar is held by the shade |  | |
| 30068 | B13/X4 | white Ral9003 | the collar is held by the shade |  | |
| 30071 | B13/X13 | grey | the collar is held by the shade |  | |
| 30070 | B13/X12 | polished brass | the collar is held by the shade |  | |

Base for surface mounting

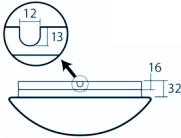
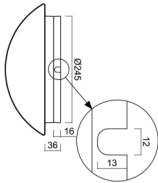
| Product code | Name | Color | Description | Picture | Drawing |
|--------------|--------|---------------|-------------|--|---|
| 33504 | B13/BP | white Ral9003 | |  |  |

Lampshade

| Product code | Name | Color | Description | Picture | Drawing |
|--------------|------|-------|-------------|--|---------|
| 20081 | 025 | white | |  | |