



## ELSA 2

---

LED-1L14E500BT13/025 HF 3K#

[WWW.OSMONT.CZ](http://WWW.OSMONT.CZ)

# ELSA 2

Product code: ELS59446

Type: LED-1L14E500BT13/025 HF 3K#

Short description of the luminaire: White surface-mounted LED light with sensor with TRIPLEX OPAL glass shade.



## Technical

|                              |                                |
|------------------------------|--------------------------------|
| Types of luminaires          | Sensor                         |
| Mounting type                | surface mounted                |
| Base material                | steel                          |
| Shade material               | three-layer glass TRIPLEX OPAL |
| Base color                   | white Ral9003                  |
| Shade color                  | white                          |
| Holding the shade            | bayonet                        |
| Mounting location            | ceiling/wall                   |
| Width                        | 300 mm                         |
| Length                       | 300 mm                         |
| Height                       | 86 mm                          |
| Diameter                     | ø 300 mm                       |
| mounting holes (diameter)    | 3xø5mm                         |
| Installation wire (diameter) | 2xø16mm                        |
| Energy Class                 | D                              |
| Impact strength              | IK01                           |
| Operating temperature        | from -20°C to +30°C            |

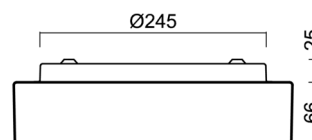
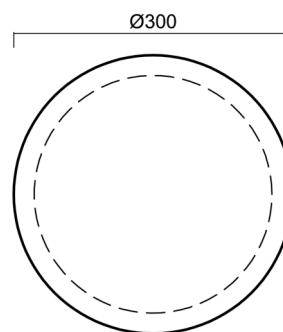

## Electric

|                                     |                     |
|-------------------------------------|---------------------|
| Power consumption                   | 13 W                |
| Ingress Protection                  | IP44                |
| Socket                              | LED modul           |
| Sensor                              | HF                  |
| terminal block                      | snap terminal block |
| Automatic circuit breaker type B10A | 37 pcs              |
| Automatic circuit breaker type B16A | 59 pcs              |
| Automatic circuit breaker type C10A | 37 pcs              |
| Automatic circuit breaker type C16A | 59 pcs              |

## Luminous

|                             |              |
|-----------------------------|--------------|
| Lum. flux of luminaire      | 1460 lm      |
| Lum. flux of light source   | 2000 lm      |
| Luminaire efficacy          | 112 lm/W     |
| Temperature                 | 3000 K       |
| Rated life time LED L80/B10 | 100000 hours |
| CRI                         | Ra80         |
| MacAdam                     | 3            |
| Blue light hazard           | Risk group 0 |

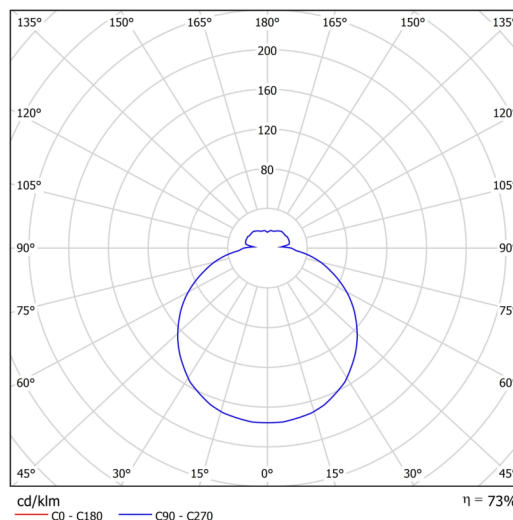

Eulum data for calculation programs are available at [www.osmont.cz](http://www.osmont.cz).

Logistic

|                   |                      |
|-------------------|----------------------|
| EAN               | 8591728095512        |
| Weight NTTO       | 2.1 Kg               |
| Weight BTTO       | 2.4 Kg               |
| Number of cartons | 1 pcs                |
| Package volume    | 0.012 m <sup>3</sup> |
| Package 1 width   | 0.32 m               |
| Package 1 length  | 0.31 m               |
| Package 1 height  | 0.12 m               |
| Warranty*         | 60 months            |

\*The warranty for the batteries is valid for 12 months from the date of purchase.

Installation dimensions:

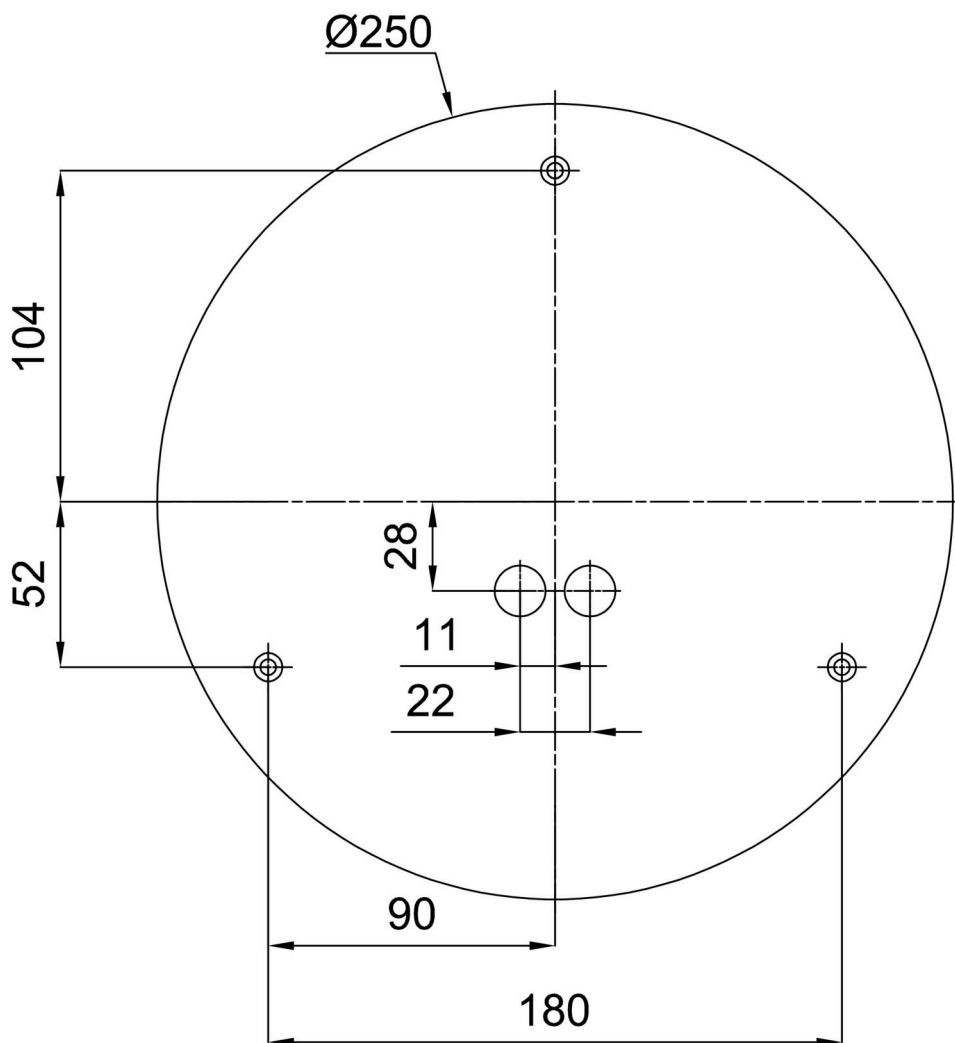

Additional assortment:

Decorative collar

| Product code | Name    | Color                    | Description                     | Picture  | Drawing |
|--------------|---------|--------------------------|---------------------------------|--|---------|
| 30069        | B13/X14 | polished stainless steel | the collar is held by the shade |    |         |
| 30068        | B13/X4  | white Ral9003            | the collar is held by the shade |    |         |
| 30071        | B13/X13 | grey                     | the collar is held by the shade |    |         |
| 30070        | B13/X12 | polished brass           | the collar is held by the shade |  |         |

Base for surface mounting

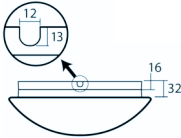
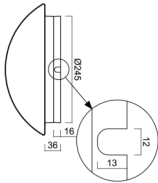
| Product code | Name   | Color         | Description | Picture  | Drawing   |
|--------------|--------|---------------|-------------|--|---|
| 33504        | B13/BP | white Ral9003 |             |  |  |

Lampshade

| Product code | Name | Color | Description | Picture  | Drawing |
|--------------|------|-------|-------------|--|---------|
| 20081        | 025  | white |             |  |         |