



ELSA 1 IP

IN-12BD12/023*

WWW.OSMONT.CZ

ELSA 1 IP

Product code: ELS71189

Type: IN-12BD12/023*

Short description of the luminaire: White surface-mounted E27 light ON/OFF with TRIPLEX OPAL glass shade

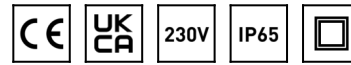

Technical

Types of luminaires	Classic on/off
Mounting type	surface mounted
Base material	polypropylene composite
Shade material	three-layer glass TRIPLEX OPAL
Base color	white Ral9003
Shade color	white
Holding the shade	bayonet
Mounting location	ceiling/wall
Width	250 mm
Length	250 mm
Height	90 mm
Diameter	ø 250 mm
mounting holes (diameter)	3xø5mm
Installation wire (diameter)	2xø16mm
Impact strength	IK01
Operating temperature	from -20°C to +30°C

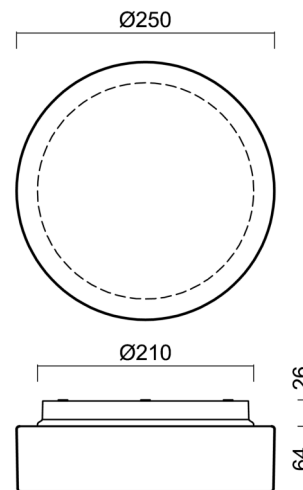

Electric

Voltage type	AC
AC voltage	220 - 240 V
Power consumption	7 W
Coverage class	2
Ingress Protection	IP65
Socket	E27
terminal block	snap terminal block

Luminous

Blue light hazard	Risk group 0
-------------------	--------------

Eulum data for calculation programs are available at www.osmont.cz.

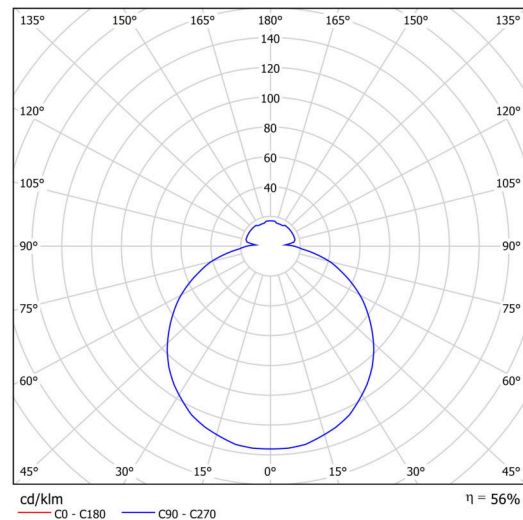

Logistic

EAN	8591728711894
Weight NTTO	1.5 Kg
Weight BTTO	1.7 Kg
Number of cartons	1 pcs
Package volume	0.008 m ³
Package 1 width	0.27 m
Package 1 length	0.26 m
Package 1 height	0.11 m
Warranty*	60 months

*The warranty for the batteries is valid for 12 months from the date of purchase.

Installation dimensions:

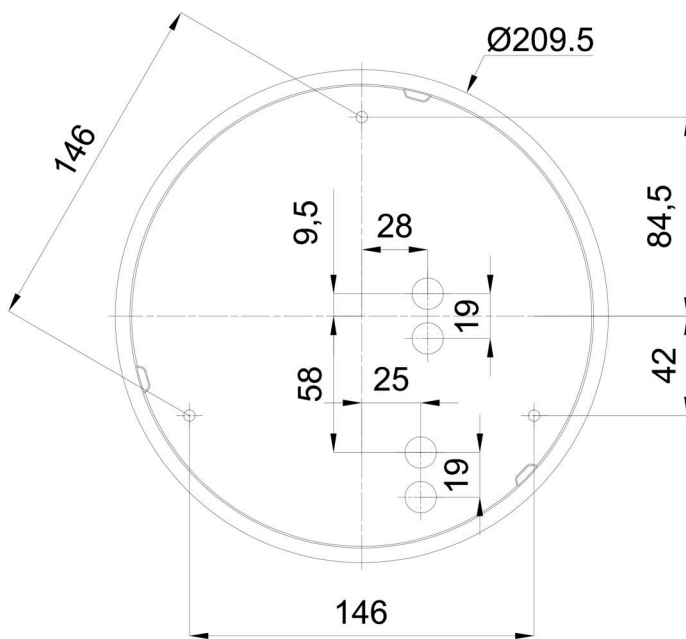

Additional assortment:

Decorative collar

Product code	Name	Color	Description	Picture	Drawing
30061	B12/X14	polished stainless steel	the collar is held by the shade		
30060	B12/X4	white Ral9003	the collar is held by the shade		
30063	B12/X13	grey	the collar is held by the shade		
30062	B12/X12	polished brass	the collar is held by the shade		

Lampshade

Product code	Name	Color	Description	Picture	Drawing
20080	023	white		