



ELSA 1

LED-1L12E700BT12/023 HF 3/4K#

WWW.OSMONT.CZ

ELSA 1

Product code: ELS71187

Type: LED-1L12E700BT12/023 HF 3/4K#

Short description of the luminaire: White surface-mounted LED light with sensor with TRIPLEX OPAL glass shade

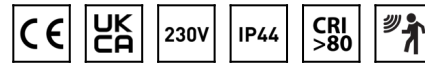

Technical

Types of luminaires	Sensor
Mounting type	surface mounted
Base material	steel
Shade material	three-layer glass TRIPLEX OPAL
Base color	white Ral9003
Shade color	white
Holding the shade	bayonet
Mounting location	ceiling/wall
Width	250 mm
Length	250 mm
Height	84 mm
Diameter	ø 250 mm
mounting holes (diameter)	3xø5mm
Installation wire (diameter)	2xø16mm
Energy Class	D
Impact strength	IK01
Operating temperature	from -20°C to +30°C

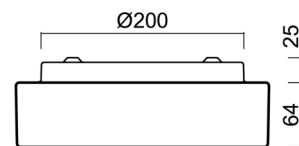
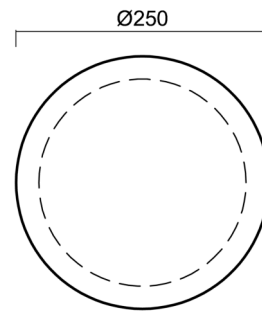

Electric

Power consumption	10 W
Ingress Protection	IP44
Socket	LED modul
Sensor	HF
terminal block	snap terminal block
Automatic circuit breaker type B10A	50 pcs
Automatic circuit breaker type B16A	78 pcs
Automatic circuit breaker type C10A	84 pcs
Automatic circuit breaker type C16A	130 pcs

Luminous

Lum. flux of luminaire	950/990 lm
Lum. flux of light source	1350/1410 lm
Luminaire efficacy	95 lm/W
Temperature	3000/4000 K
Rated life time LED L80/B10	100000 hours
CRI	Ra80
MacAdam	3
Blue light hazard	Risk group 0

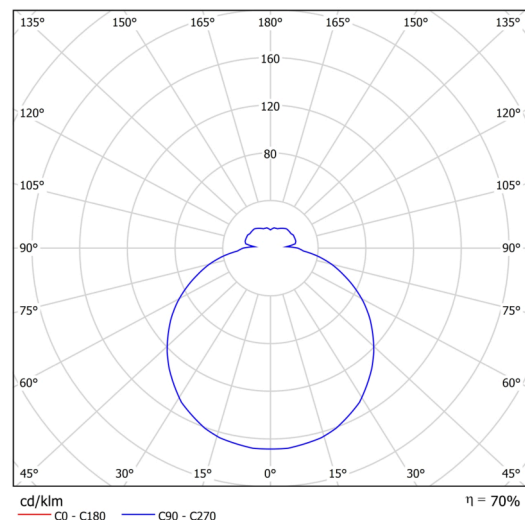

Eulum data for calculation programs are available at www.osmont.cz.

Logistic

EAN	8591728097806
Weight NTTO	1.7 Kg
Weight BTTO	1.9 Kg
Number of cartons	1 pcs
Package volume	0.008 m ³
Package 1 width	0.27 m
Package 1 length	0.26 m
Package 1 height	0.11 m
Warranty*	60 months

*The warranty for the batteries is valid for 12 months from the date of purchase.

Installation dimensions:

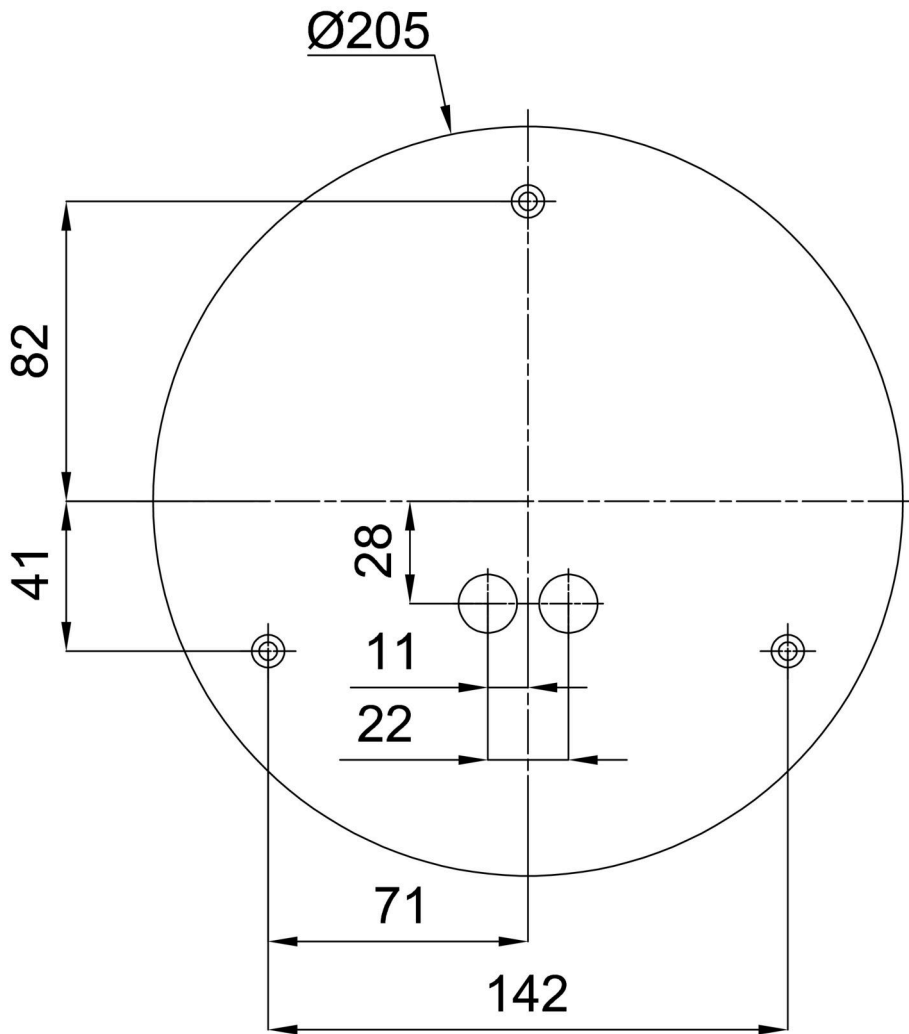

Additional assortment:

Decorative collar

Product code	Name	Color	Description	Picture	Drawing
30061	B12/X14	polished stainless steel	the collar is held by the shade		
30060	B12/X4	white Ral9003	the collar is held by the shade		
30063	B12/X13	grey	the collar is held by the shade		
30062	B12/X12	polished brass	the collar is held by the shade		

Lampshade

Product code	Name	Color	Description	Picture	Drawing
20080	023	white		