



## EDNA P5

---

LED-1L16E700ZK88/028/z2 DALI 3K#

[WWW.OSMONT.CZ](http://WWW.OSMONT.CZ)

# EDNA P5

Product code: EDN61211

Type: LED-1L16E700ZK88/028/z2 DALI 3K#

Short description of the luminaire: White pendant LED light DALI with TRIPLEX OPAL glass shade.



## Technical

Types of luminaires	Dimmable
Mounting type	Suspended - rod
Base material	steel
Shade material	three-layer glass TRIPLEX OPAL
Base color	white Ral9003
Shade color	white
Holding the shade	folding system
Mounting location	ceiling
Width	490 mm
Length	490 mm
Height	130 mm
Diameter	ø 490 mm
Hinge length	400 mm
mounting holes (diameter)	2xø5mm
Installation wire (diameter)	2xø16mm
Energy Class	D
Impact strength	IK01
Operating temperature	from -20°C to +30°C

## Electric

Power consumption	34 W
Ingress Protection	IP40
Socket	LED modul
terminal block	screw terminal block
Automatic circuit breaker type B10A	18 pcs
Automatic circuit breaker type B16A	28 pcs
Automatic circuit breaker type C10A	30 pcs
Automatic circuit breaker type C16A	46 pcs

## Luminous

Lum. flux of luminaire	3330 lm
Lum. flux of light source	5050 lm
Luminaire efficacy	97 lm/W
Temperature	3000 K
Rated life time LED L80/B10	100000 hours
CRI	Ra80
MacAdam	3
Blue light hazard	Risk group 0

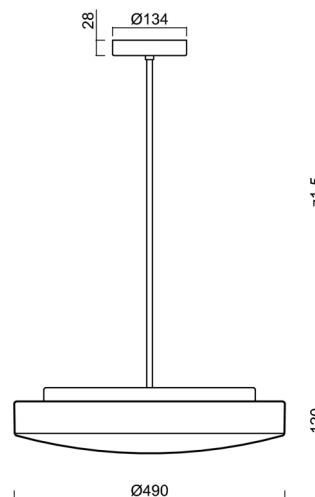
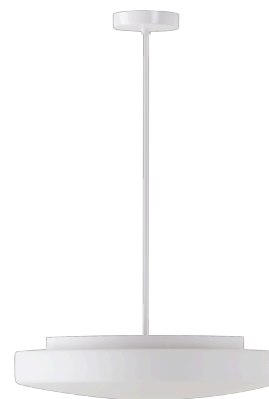

Eulum data for calculation programs are available at [www.osmont.cz](http://www.osmont.cz).

Logistic

EAN	8591728093570
Weight NTTO	5.6 Kg
Weight BTTO	6.1 Kg
Number of cartons	2 pcs
Package volume	0.047 m <sup>3</sup>
Package 1 width	0.515 m
Package 1 length	0.495 m
Package 1 height	0.14 m
Warranty*	60 months

\*The warranty for the batteries is valid for 12 months from the date of purchase.

Installation dimensions:



## Additional assortment:

## Lampshade

Product code	Name	Color	Description	Picture	Drawing
20070	028	white			